

G

2023

365 días a  
tu lado!®



**BIC**®

*graphic*

Piensa en “el bolígrafo”, o en “el encendedor”.  
Piensa en un servicio eficiente y fiable.  
Piensa en sostenibilidad e iniciativas sociales.  
Piensa en un trabajo conjunto para encontrar  
las mejores soluciones.

Y ahora piensa en todo lo que podemos hacer  
para una marca, para tu marca.

Piensa a lo grande.

# Think BIC

# Índice

## BIC GRAPHIC

8

Iconicidad	8	Sostenibilidad	18
Creatividad	10	Innovación	24
Cronografía BIC®	12	Técnicas de impresión	26
Confiabilidad	14	Gama britePix™ digital a todo color	28
Responsabilidad social	16	Gama sostenible Ecolutions®	30

## INSTRUMENTOS DE ESCRITURA BIC®

36

### BOLÍGRAFOS

BIC® Style	38
BIC® Round Stic®	42
BIC® Round Stic® Bguard™ antibacterial	48
BIC® M10® Clic	50
BIC® Media Clic	52
BIC® Media Clic Grip	58
BIC® Media Clic Bguard™ antibacterial	63
BIC® Media Clic Bguard™ antimicrobial Ecolutions®	66
BIC® Media Clic Bio-Based Ecolutions®	68
BIC® Media Clic Bio-Based BGuard™ antibacterial	71
BIC® Media Clic Shine	73
BIC® Media Clic Glacé	74
BIC® Clic Stic	76
BIC® Clic Stic BGuard™ antibacterial	84
BIC® Clic Stic Stylus BGuard™ antibacterial	86
BIC® Super Clip	88
BIC® Super Clip BGuard™ antibacterial	94
BIC® Super Clip Advance	96
BIC® Super Clip Glacé	100
BIC® Super Clip Glacé Advance	100
BIC® Super Clip Soft	102
BIC® Super Clip Soft Advance	102
BIC® Super Clip Origin	104
BIC® Wide Body™	106
BIC® Wide Body™ BGuard™ antibacterial	112
BIC® 4 Colours®	114
BIC® 4 Colours® Soft	118
BIC® 4 Colours® Wood Style	120
BIC® 4 Colours® Sun	122
BIC® 4 Colours® Fashion	124

BIC® 4 Colours® Shine	126
BIC® 4 Colours® Glacé	128
BIC® 4 Colours® Fine	130
BIC® 4 Colours® Fluo	131
BIC® 4 Colours® 3+1 <sup>HB</sup>	132

### BOLÍGRAFOS METÁLICOS

BIC® Metal Pro	134
BIC® Cristal® Re'New™	138

### ROLLERS Y GELES

BIC® Grip Roller	142
BIC® XS Finestyle	146
BIC® Intensity® Gel Clic	148

### RESALTADORES Y MARCADORES

BIC® Brite Liner® Grip	152
BIC® Velleda® White Board Marker Fine	154
BIC® Velleda® White Board Marker Grip	155
BIC® Mark-It Permanent Marker	156
BIC® Permanent Marker Ecolutions®	157

### PORTAMINAS

BIC® Matic®	160
BIC® Media Clic Portaminas	52
BIC® Media Clic Grip Portaminas	58

### LÁPICES

BIC® Evolution® Ecolutions®	164
Sprout™ Lápiz de grafito	168

---

## OTROS INSTRUMENTOS DE ESCRITURA 170

### BOLÍGRAFOS DE PLÁSTICO

Basic Pen	172
Click Pen	174
Striped Grip Pen	176

### BOLÍGRAFOS CON STYLUS

Sleek Stylus Pen	178
------------------	-----

---

## LIBRETAS 180

### ROCKETBOOK®

Rocketbook® Core Executive A5	184
Rocketbook® Fusion Executive A5	186
Rocketbook® Core Mini A6	188

---

## ENCENDEDORES Y FUNDAS BIC® 190

### ENCENDEDORES

Encendedor BIC® J25	196
Encendedor BIC® J23	200
Encendedor BIC® J26	204
Encendedor BIC® J38	208

### FUNDAS

Funda BIC® Styl'it Luxury	212
Funda BIC® Aluminium Flat	214
Funda BIC® Clip	215
Funda BIC® 3D	216

### OTROS PRODUCTOS

BIC® Pocket Ashtray	218
---------------------	-----

---

## ENVASES BIC® 220

Envases BIC® Eolutions®	222
Envases BIC®	224

---

## INFORMACIÓN GENERAL 228

¡Lo hacemos simple!	230	Información general	234
Servicio de impresión en 48 horas	231	Índice de producto	235
Símbolos y abreviaturas	232	Gama de colores	236



**Una vez más,  
¡Hola!**

# El icono, en iconos.

Cuando una marca se convierte en un icono, el escenario de repente cambia. Sube el nivel de exigencia. Por eso llega un punto en el que sobran las palabras y solo los hechos valen. Lo objetivo: aquello que no está sujeto a interpretación alguna.

El icono es esto.

## Certificados



ISO CERTIFIED  
ISO 9001 - ISO 14001



RECONOCIMIENTO  
DORADO



WEB NEUTRAL  
EN CO2



AUDITADOS POR  
COCA-COLA



ETIQUETA  
IMPRIM'VERT



MIEMBROS DE  
UN GLOBAL COMPACT



AUDITADOS POR WCA



MIEMBROS DE AMFORI Y  
AUDITADOS POR BSCI



MIEMBROS DE SEDEX Y  
AUDITADOS POR SMETA

# Innovación e iconicidad

Vocación constante de innovar que se manifiesta en la implementación de nuevas técnicas de personalización de producto, en el lanzamiento de nuevos productos más sostenibles y de mayor calidad, y en nuevos acabados especiales y que siguen las tendencias, para los productos más icónicos. Una marca mundialmente reconocible, un icono vanguardista por su talante innovador.

---

# Confiableidad

Un referente, que también lo es en cumplimiento de los más altos estándares de calidad y seguridad, y en compromiso social, medioambiental y ético.

---

# Proximidad

Producción local, más cerca de ti, para reducir la huella de carbono. Estamos cerca de ti, nos anticipamos a tus necesidades ofreciendo el máximo detalle en la personalización de productos y herramientas digitales para la configuración de estos de la manera más cómoda.

# ¿Cómo una marca llega a convertirse en un icono?

En nuestro caso la respuesta es muy simple. Es lo que llamamos pura *joyful simplicity*: ofrecer soluciones simples y sencillas que nos hacen la vida más fácil.

Todo empieza con un pequeño gesto: alguien busca, saca un bolígrafo del fondo de un bolsillo y traza un boceto en una hoja de papel o escribe algo. Un gesto pequeño pero universal. Algo que todos hemos hecho alguna vez. Y así es como ese bolígrafo se convierte algo más que eso: en el símbolo de un momento de inspiración. En un icono.

## MoMA

2001 - BIC® CRISTAL® SE INTRODUCE EN EL MUSEO MoMA, NEW YORK.

El boli 'BIC® Cristal®' está considerado como el utensilio de escritura manual con mejor diseño del mundo, esto ha propiciado que forme parte, desde el año 2001, de la colección permanente del MoMA (Museo de Arte Moderno de Nueva York).



## Centre Pompidou

2006 - BIC EN LA COLECCIÓN DEL MUSEO NACIONAL DE ARTE MODERNO DE PARÍS.

El bolígrafo BIC® Cristal®, el encendedor de bolsillo BIC® de tamaño grande y las maquinillas de afeitar BIC® Classic Original y Classic Sensitive fueron incluidos como parte de la colección permanente del Museo Nacional de Arte Moderno/Centre de Création Industrielle- Centro Georges Pompidou París.

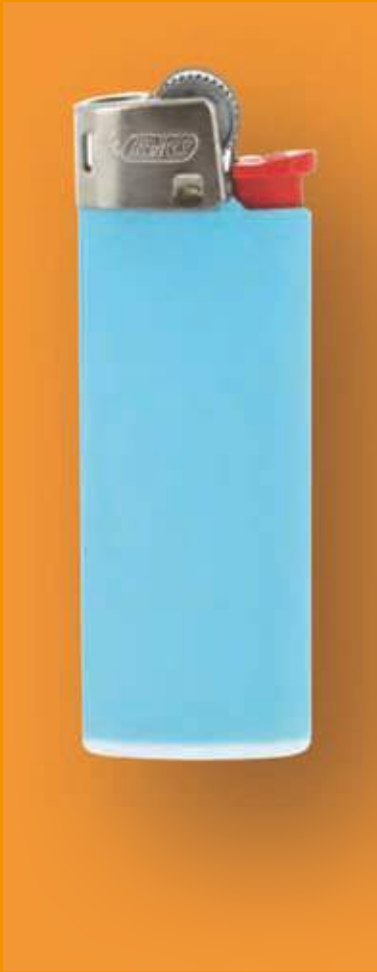

1973



1950



1975

# Una casa, un árbol, un poema.

Piensa en todo lo que se puede  
imaginar con un bolígrafo en la mano.

---

La punta del bolígrafo que tienes en la mano entra en contacto con la hoja de papel. Imaginas algo y la mano lo dibuja. ¿Una pantera? ¿Un estadio? ¿Una muela? Cualquier cosa que puedas imaginar. Ese dibujo representa perfectamente como la marca se convirtió en un icono.

Igual que la colección de 250 piezas creadas o inspiradas por productos BIC®, de artistas reconocidos internacionalmente. Igual que los productos BIC® que han inspirado a marcas de prestigio de todo el mundo:

---

## Solo imagina.



### **BOLÍGRAFO BIC Y PINEL & PINEL**

BIC® Cristal enfundado en cuero por Maison Pinel & Pinel.



### **BOLÍGRAFO BIC & TOURNAIRE**

Una serie limitada (500 uds) de bolígrafos BIC® 4 Colours®, numerados. Cada bolígrafo está hecho como una joya, a mano por Tournaire House.



### **BANDEJAS DE CERÁMICA PARA BOLÍGRAFOS**

Desde 2016, la artista francesa Catherine Courty-Truelle ha estado creando bandejas de cerámica para bolígrafos, cada una con una escritura de un producto BIC®.



### **UN BROCHE BORDADO A MANO DE MACON Y LESQUOY**

Los diseñadores franceses Macon y Lesquoy agregaron a su gama dos broches bordados a mano con forma de un BIC® Cristal® y un BIC® 4 Colours®.

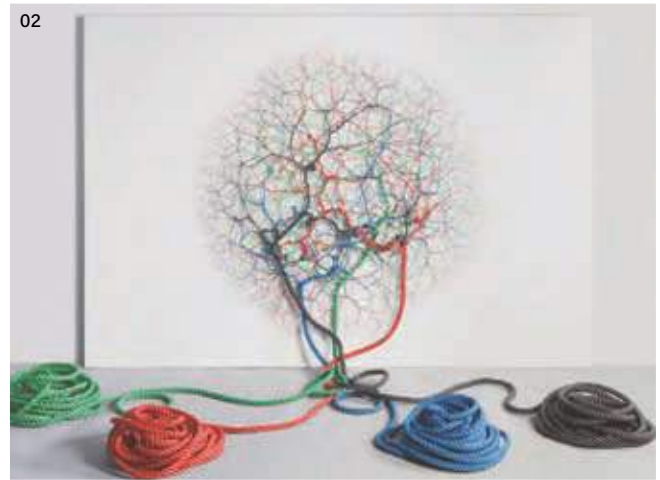

01. Ubuntu - Astral Msekeli 02. CICLOTRAMA 115 - Janaina Mello Landini 03. Timmy - The Kid 04. La Collection BIC au 104 : sublimation du basique 05. THE BIC CONTEMPORARY ART COLLECTION.



# Cambian los tiempos, permanece el espíritu.

---

Piénsalo: el mundo era muy diferente hace casi un siglo. ¿Qué podría llevar a un par de jóvenes a crear un proyecto para aportar soluciones sencillas para la vida cotidiana de la gente? Seguramente muchas ideas y encuentros, algunas decisiones y cientos de razonamientos. Pero sobre todo, un gran espíritu innovador.

Durante este tiempo han pasado muchas cosas. Algunos dicen que todo ha cambiado mucho; y, sin embargo, hay algo que ha permanecido inalterable.

---

**1944**

Marcel Bich funda PPA  
(Portaplumas, Portaminas y Accesorios)  
en Clichy-la-Garonne (Francia), sentando  
así las bases del grupo BIC®.





**1950**  
Nace la marca BIC®.

Lanzamiento del BIC® Cristal® en Francia



**1951**  
Primera exportación (a Bélgica).



**1954**  
Implantación en Italia.

-Apertura de una unidad de fabricación bajo licencia en España para cubrir la Península Ibérica.

**1956**  
Implantación en Brasil.



**1957**  
Compra del grupo inglés Biro Swan que abre a BIC® los mercados de la zona esterlina.

**1958**  
Implantación en EE.UU. y consolidación en el Norte de África y Oriente Medio.

**1961**  
Lanzamiento de una nueva punta, hecha de carburo de tungsteno.

Raymond Savignac diseña el "bonhomme BIC", que se ubica junto a las letras BIC formando el logo de la marca.



**1969**  
Lanzamiento de la actividad de productos promocionales.

**1970**  
Lanzamiento del BIC® 4 Colours.



**1972**  
Entrada de la Société BIC a la Bolsa de París.

**1973**  
Lanzamiento del primer encendedor BIC® Maxi.



**1975**  
Lanzamiento de la primera maquinilla de afeitar BIC monobloque de una cuchilla.



**1995**  
Consolidación del mercado del este y del centro de Europa.

Expansión en Europa de la actividad de impresión publicitaria BIC Graphic.

**2001**  
El bolígrafo BIC® Cristal® está expuesto en el museo MoMA de New York.



**2003**  
Lanzamiento del programa BIC de desarrollo sostenible.

**2016**  
Creación de la Fundación Corporativa BIC para la educación.



**2017**  
En colaboración con Plas Eco, lanzamiento de la gama de mobiliario Plas Eco hecha con bolígrafos reciclados.



**2018**  
Exposición de la Colección BIC de Arte Contemporáneo.



**2020**  
Adquisición de Rocketbook, marca de libretas inteligentes reutilizables.



**2022**  
Adquisición de INKBOX, fabricante líder de tatuajes semipermanentes de alta calidad, y Tattly, fabricante de calcomanías de tatuajes temporales de alta calidad e ingeniosamente diseñadas.



**2022**  
BIC® adquiere AMI (Advanced Magnetic Interaction), una pequeña empresa francesa especializada en tecnología de interacción aumentada, y creadora de la tableta digital ISKN Repaper, que permite a los usuarios capturar escritos y dibujos en papel en un formato electrónico.



# ¿Por qué confiamos en quién confiamos?

Hay muchas cosas que hacen que confíes en quien confías. No es solo una cosa, son muchas.

Algunas son tangibles y fáciles de ver; son cifras que muestran liderazgo, que demuestran que somos la marca preferida por el consumidor y lo hemos sido durante más de 50 años, que nos hablan de producción local, de productos de calidad contrastada, o de estar siempre ahí, aportando soluciones sostenibles y competitivas.

Pero hay otras cosas, y esas no se pueden tocar porque son pura emoción.

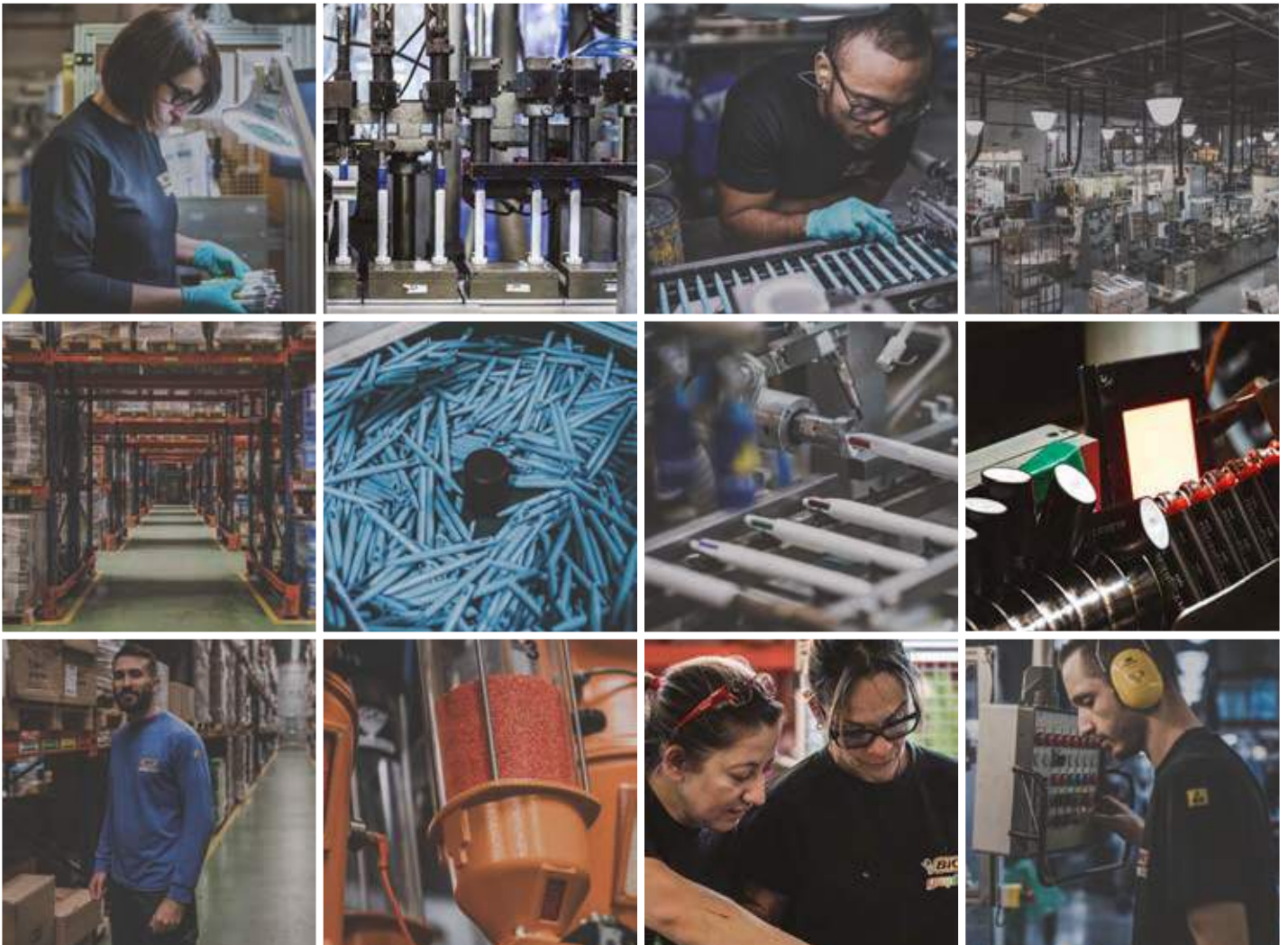

# 91 %

De productos producidos en el grupo BIC®.

---

# 24

Fábricas en 4 continentes.

---

# 10,471

Empleados en todo el mundo.

---

# 100 %

De los instrumentos de escritura impresos en BIC Graphic Europe.

---

# 26 M.

De productos BIC® son elegidos cada día en todo el mundo.

# RSC antes de que se hablara de RSC.

Primero van los hechos.

---

Durante más de 75 años, hemos trabajado en acciones para apoyar la educación porque creemos que es un derecho fundamental y esencial de las personas. En ese contexto, en 2016 nace la BIC Corporate Foundation para apoyar iniciativas educativas en todo el mundo, básicamente en tres líneas: suministro de subvenciones y donación de productos, voluntariado en nuestras comunidades y formación de asociaciones globales.

---

Una de las iniciativas más relevantes en los últimos años ha sido la BIC Global Education Week en la que, cada año durante una semana, los miembros del equipo trabajan activamente para mejorar las condiciones de aprendizaje en todo el mundo a través de actividades de voluntariado específicas. Hechos.

Y ahora, las palabras.

Concretamente tres palabras que forman ese concepto del que todo el mundo habla, la RSC. Sí, podemos decirlo alto y claro: mientras todos hablan de RSC, nosotros actuamos desde hace mucho tiempo en esa dirección, en la de la Responsabilidad Social Corporativa.

Porque primero van los hechos, y después las palabras.





Corporate  
Foundation  
*We Give to Create*



# Ser realmente sostenible es pensar más allá de lo obvio.

---

Hagámoslo. Pensemos más allá de lo obvio y empecemos por algo fácil: viajemos al pasado. Concretamente a hace 20 años. Entonces apenas se empezaba a hablar de “sostenibilidad”, y sin embargo nuestro enfoque como marca ya se basaba en el desarrollo sostenible.

---

Aquello era solo el principio. Acciones para fomentar la innovación de productos, como la línea Origin hecha a partir de materiales 100% Bio-Based, actuar contra el cambio climático y salvar el medio ambiente, entre otras. Y todo, involucrando proactivamente a las empresas proveedoras.

Hoy, la sostenibilidad sigue siendo parte fundamental de nuestra actividad, y es una muestra más de nuestro compromiso de pensar más allá de lo obvio, y actuar como una empresa responsable.







# De palabras a acciones

Si decimos "Writing the future together" puede que alguien piense que es solo una frase bonita. Rotundamente no; se trata de un ambicioso programa de desarrollo sostenible, con objetivos claramente medibles para 2025.

Vayamos uno a uno:



Fomentar la innovación sostenible en nuestros productos.



Actuar contra el cambio climático.



Comprometernos con la seguridad en el trabajo.



Implicar a los proveedores de forma proactiva.



Trabajar por una vida mejor a través de la educación.

Nuestro compromiso va más allá de tendencias o contextos.  
Nuestro compromiso son los hechos.

Nuestros más recientes premios en la industria:



1<sup>er</sup> PUESTO EN  
Excelencia económica  
Iniciativa Social  
Productos sostenibles

2<sup>do</sup> PUESTO EN  
Iniciativa social

3<sup>er</sup> PUESTO EN  
Iniciativa medioambiental





***Writing  
the future  
together***





# Imagina lo que se puede hacer con un puñado de bolis usados

Imagina. Imagina más;  
deja volar la imaginación.



Porque un puñado de bolis usados es mucho más que eso. Podías intuirlo, porque el 100% de los instrumentos de escritura BIC® son reciclables gracias a UbiCity™.

Pero ahora imagina qué podemos hacer con todo ese material reciclable. Pues esto es lo que hicimos:



- Desde 2011 colaboramos en Europa con **Terracycle**®, una empresa pionera en la industria del reciclaje de plástico a través de la cual llevamos a cabo la colecta de instrumentos de escritura usados.
- Los materiales se convierten en tablonos gracias a **Govaplast**.
- Y los tablonos son convertidos en muebles urbanos gracias a **Plas Eco**.

**Y así, un puñado de bolis usados se convierten en una mesa, una silla o un banco.**

**Es así, como no solo imaginamos, también actuamos como una empresa responsable.**



Larga vida a los encendedores.



Sí, incluso más larga de lo que puedes imaginar. Y es que como parte de nuestra vocación innovadora en economía circular, llevamos más de 7 años desarrollando la tecnología que nos permite separar las piezas de los encendedores usados, y posteriormente reciclarlas. Además, estamos llevando a cabo en España dos programas de recogida de encendedores.

**¡Larga, muy larga vida, a los encendedores!**

# Bienvenido al futuro.

---

Esto es un viaje en el tiempo. A las necesidades que los consumidores aún no saben que tendrán. Porque esto es innovar: anticiparse a sueños y deseos. Y hacerlo como se suele decir con "el consumidor en el centro"; es decir pensando en él, o mejor dicho pensando como él.

---

Todo esto se traduce en el desarrollo de tecnologías que permiten procesos de producción sostenibles y una reducción de la huella de carbono; en contar con las últimas tecnologías de impresión; en soluciones para hacer productos más duraderos; o en funcionalidades que aporten excelencia a los diseños.

El futuro está por llegar. Pero nosotros ya nos hemos instalado en él y también hay sitio para ti.

*Bienvenido.*

¡NUEVO!

# THE FUTURE IS ORIGIN

Si hay algo que sabemos del futuro es que será más verde o no será. Por eso a la hora de innovar, el diseño ecológico tiene un papel relevante y por eso llevamos más de 20 años trabajando en esta dirección.

**ORIGIN**  **BIO  
BASED**



**Aceite de ricino de origen biológico**



**Serrín de madera**  
De bosques europeos gestionados de forma sostenible



**Talco**  
Extraído en Europa

## Ser o no ser

En el contexto de la innovación en producto y de la apuesta por el diseño ecológico, abrimos una nueva etapa con los productos **Origin** fabricados a partir de material de origen biológico compuesto de polímeros naturales, excluyendo elementos provenientes del petróleo y de combustibles fósiles.

Ser o no ser. Como nosotros, que somos pioneros en sostenibilidad, desde antes que todo el mundo hablara de cómo era de importante serlo. Ser o no ser, esa es la cuestión; y para nosotros lo es desde hace mucho, mucho tiempo.

# Técnicas de Impresión

## PRUEBAS DE CONTROL DE CALIDAD

Nuestro proceso de personalización está regulado por estrictos controles de calidad y va acorde con las regulaciones europeas:

- Prueba de adhesión
- Prueba de arañazos (ISO 12137:11)
- Prueba de abrasión
- Prueba de resistencia
- Prueba de exposición a la transpiración artificial

Todos los pedidos de productos impresos en las fabricas BIC Graphic, pasan por 4 controles distintos:

- Control de aspecto estético
- Control de color de impresión
- Control de la adherencia de impresión
- Resistencia a los arañazos







¡Con más de 50 años de experiencia como garantía!



### Serigrafía

Técnica perfecta para crear impresiones de alta calidad, reproduciendo colores exactos.



### BritePix™ Personalisation

Personalización britePix™. Personaliza cada unidad en el mismo pedido britePix™.

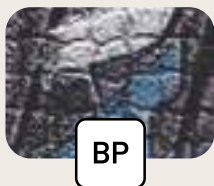

### BritePix™ Texture

BritePix™ Texture es un añadido premium al concepto britePix™ - ahora no sólo puedes verlo sino que ¡también puedes sentirlo!

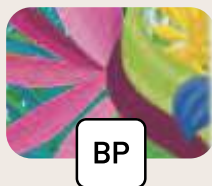

### BritePix™

Impresión a todo color con resultados fotográficos de alta calidad que asegura una impresión duradera de su logo.

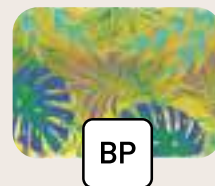

### BritePix™ Digital

La solución para una impresión a todo color. Ahora en cuerpos de colores.



### Puffy Glitter

Embelce tus diseños con el efecto brillante de la purpurina. ¡Mira y siente su textura brillante y coloreada!

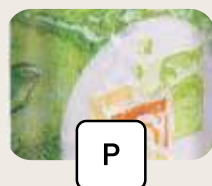

### Puffy

Destaca tu marca con nuestro efecto "puffy" que da relieve a tu logo.

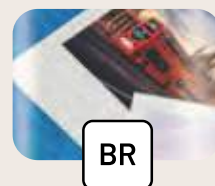

### Brilliant

Escoge el acabado brillante para obtener un efecto final deslumbrante.

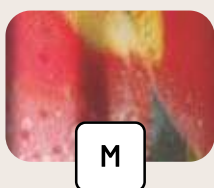

### Metallic

¡Crea magníficos efectos metálicos en textos, imágenes y fondos!

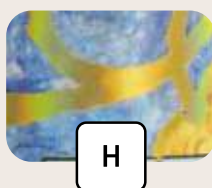

### Holographic

¡Destaca entre la multitud! Juega con atractivos reflejos dorados o plateados en tu diseño.



### Matt

Utiliza el acabado mate para dar toques de elegancia a tu diseño.



### UV

¡Destaca tu marca con el acabado de relieve brillante! Combina mate y brillante para resaltar contrastes.

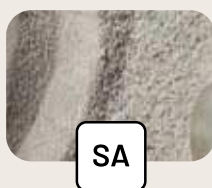

### Sandy

Crea un efecto arena con una textura granulada.



### Laser

El grabado laser te permitirá dar un efecto elegante a tus comunicaciones. Utilízalo y consigue una impresión duradera.

# La solución para una comunicación a todo color

**britePix™**

BIC GRAPHIC EUROPE PIONERO  
EN IMPRESIÓN DIGITAL



## **BritePix™ Texture**

BritePix™ Texture es un añadido premium al concepto britePix™ - ahora no sólo puedes verlo sino que ¡también puedes sentirlo!



## **BritePix™**

Impresión a todo color con resultados fotográficos de alta calidad que asegura una impresión duradera de su logo.



## **BritePix™ Digital**

La solución para una impresión a todo color. Ahora en cuerpos de colores.



## **BritePix™ Personalisation**

Personalización britePix™. Personaliza cada unidad en el mismo pedido britePix™.





BIC® Evolution® Evolutions®



BIC® Media Clic



BIC® Round Stic®



BIC® Clic Stic



BIC® Wide Body™



BIC® Super Clip Advance



Área de  
marcaje 360°



A todo color



Calidad Fotográfica



Alta Definición



Colores brillantes  
e ilimitados

# BIC Graphic comprometido con el medio ambiente



Hecho a partir del sobrante de la fabricación de bandejas de frutas y verduras.



Hecho a partir de envases farmacéuticos

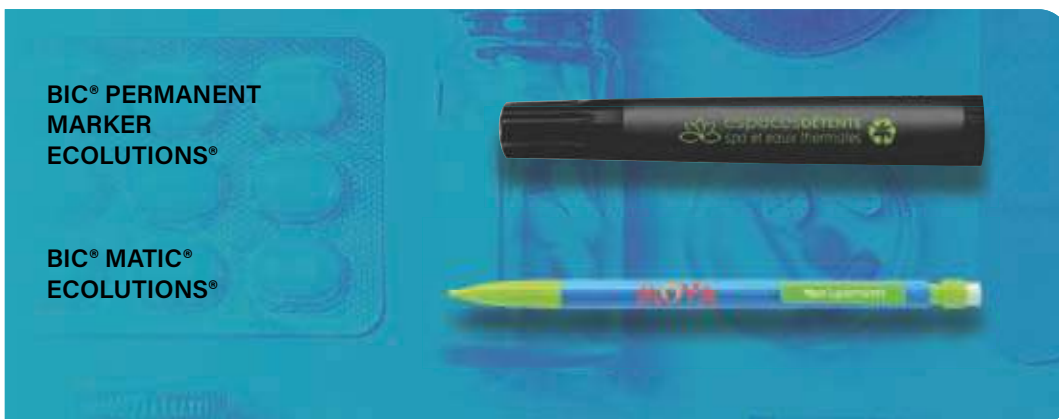

Hecho a partir del sobrante de la fabricación de piezas de automóvil.



**NUESTRA GAMA  
ECOLUTIONS®, ESTÁ HECHA  
A PARTIR DE MATERIALES  
RECICLADOS, O BIOLÓGICOS**

- Materiales reciclados y reciclables
- Materiales Bio-Based
- Nuestro papel está hecho a partir de bosques sostenibles (FSC)
- Papel reciclado



**BIC® MEDIA CLIC  
BIO-BASED  
ECOLUTIONS®**



Hecho a partir de caña de azúcar.

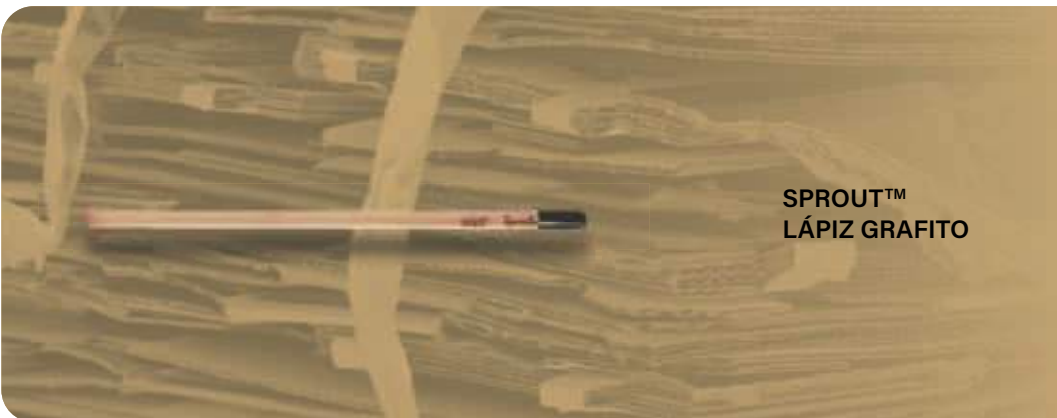

**SPROUT™  
LÁPIZ GRAFITO**



FSC y cartón reciclable.



**BIC® EVOLUTION®  
ECOLUTIONS®**



Hecho a partir de neveras recicladas y del material sobrante de la fabricación de envases de yogurt.

# BIC® Packaging Ecolutions®, envases sostenibles

La era de las buenas intenciones terminó hace tiempo. Hemos entrado en la era de los hechos. En 2004, en BIC® lanzamos el primer plan de desarrollo sostenible. Aquello marcó una serie de principios que están más vigentes que nunca. Y aquello tuvo como consecuencia hechos. Como las soluciones más sostenibles para nuestro packaging, hecho a base de material 100% reciclado, diseñado para ser reutilizado y con el objetivo de reducir la huella ecológica.

## VALOR ECOLÓGICO

- Reduce y optimiza material reciclado y reciclable.
- Reduce la huella del carbono.
- Diseñado para tener varios usos.

## MATERIALES CERTIFICADOS

- 100% cartón reciclado.
- Plásticos como PET, PP o PS que son 100% reciclables.
- Materia prima de FSC.

Para saber más,  
página 222.

## VALOR SOCIAL

- Cooperación con Treedom® con el bosque de BIC Graphic en Kenya.



El envase con el logo de Treedom® coopera con la creación de BIC Graphic Forest en Kenya. Gracias a tu apoyo en esta campaña podemos mejorar el medio ambiente (reduciendo la huella de carbono) y apoyando proyectos agro-forestales que implementan los ecosistemas sostenibles.



Cartones reciclados/  
reciclables  
Plásticos reciclables



Materia  
Prima FSC



-90,100 KG CO<sub>2</sub>  
¡Los árboles que hemos  
plantado absorben el  
CO<sub>2</sub> de la atmósfera que  
bastaría para llenar 469  
camiones.



Fabricado en Europa



# Nuevas cajas especiales para productos BIC®

Cajas de cartón FSC, personalizable en cada lado y que ofrece grandes superficies de comunicación. Ideal para ofrecer nuestros icónicos productos BIC® a través de una colección. Más que un bolígrafo, una gran manera de optimizar tus ventas.

## BIC® COLLECTION BOX

*Envase especial para:*

- BIC® 4 COLOURS®**
- BIC® WIDE BODY™**
- BIC® SUPER CLIP**
- BIC® BRITE LINER® GRIP**
- BIC® GRIP ROLLER**



**BIC® COLLECTION  
BOX 1 UNIDAD  
991212**

**BIC® COLLECTION  
BOX 2 UNIDADES  
991213**

**BIC® COLLECTION  
BOX 3 UNIDADES  
991214**

# Presentamos un nuevo servicio de recarga para tu bolígrafo.

Piensa en la agradable sensación de tener entre manos el bolígrafo perfecto para ti. Lo utilizas tanto que al final te quedas sin tinta. Pues ahora piensa que puedes alargar la vida de tu BIC® 4 Colours® o quizás de tu BIC® Super Clip Advance, con nuestro nuevo servicio de recargas. Si lo piensas bien, es una solución sostenible, coherente con nuestra forma de pensar. Si lo piensas bien, no debería sorprenderte. Y sin embargo...



BIC® SUPER CLIP ADVANCE

BIC® 4 COLOURS®

Servicio de recarga bajo petición.  
Pregunta a tu representante de ventas sobre este nuevo servicio.

**iNUEVO!**

# Recicla



Índice

01

---



# INSTRUMENTOS DE ESCRITURA BIC®

## BOLÍGRAFOS

BIC® Style	38
BIC® Round Stic®	42
BIC® Round Stic® BGuard™ antibacterial	48
BIC® M10® Clic	50
BIC® Media Clic	52
BIC® Media Clic Grip	58
BIC® Media Clic BGuard™ antibacterial	63
BIC® Media Clic BGuard™ antimicrobial Ecolutions®	66
BIC® Media Clic Bio-Based Ecolutions®	68
BIC® Media Clic Bio-Based BGuard™ antibacterial	71
BIC® Media Clic Shine	73
BIC® Media Clic Glacé	74
BIC® Clic Stic	76
BIC® Clic Stic BGuard™ antibacterial	84
BIC® Clic Stic Stylus BGuard™ antibacterial	86
BIC® Super Clip	88
BIC® Super Clip BGuard™ antibacterial	94
BIC® Super Clip Advance	96
BIC® Super Clip Glacé	100
BIC® Super Clip Glacé Advance	100
BIC® Super Clip Soft	102
BIC® Super Clip Soft Advance	102
BIC® Super Clip Origin	104
BIC® Wide Body™	106
BIC® Wide Body™ BGuard™ antibacterial	112
BIC® 4 Colours®	114
BIC® 4 Colours® Soft	118
BIC® 4 Colours® Wood Style	120
BIC® 4 Colours® Sun	122
BIC® 4 Colours® Fashion	124
BIC® 4 Colours® Shine	126
BIC® 4 Colours® Glacé	128
BIC® 4 Colours® Fine	130
BIC® 4 Colours® Fluo	131
BIC® 4 Colours® 3+1 <sup>HB</sup>	132

## BOLÍGRAFOS METÁLICOS

BIC® Metal Pro	134
BIC® Cristal® Re'New™	138

## ROLLERS Y GELES

BIC® Grip Roller	142
BIC® XS Finestyle	146
BIC® Intensity® Gel Clic	148

## RESALTADORES Y MARCADORES

BIC® Brite Liner® Grip	152
BIC® Velleda® White Board Marker Fine	154
BIC® Velleda® White Board Marker Grip	155
BIC® Mark-It Permanent Marker	156
BIC® Permanent Marker Ecolutions®	157

## PORTAMINAS

BIC® Matic®	160
BIC® Media Clic Portaminas	52
BIC® Media Clic Grip Portaminas	58

## LÁPICES

BIC® Evolution® Ecolutions®	164
Sprout™ Lápiz de grafito	168

**BIC® STYLE**

**Fácil de reconocer  
mundialmente por  
su icónico capuchón.**

**El BIC® Style ofrece  
una excelente relación  
calidad precio.**



**BIC® STYLE**

1610 Opaco

Color de tinta



01/01



01/03



01/04



01/02

●  
Solo disponible  
en tinta negra



02/02



04

●  
Solo disponible  
en tinta azul



10

●  
Solo disponible  
en tinta negra

100%

ESPECIFICACIONES



MODOS DE ESCRITURA



TÉCNICAS DE IMPRESIÓN



**BIC® STYLE**  
1610 Transparente  
Color de tinta



Personalización

**BIC® STYLE**

1610 Opaco

A SP: máx. 2 col.

**BIC® STYLE**

1610 Transparente

B SP: máx. 1 col.

Cantidad mínima 500 unidades

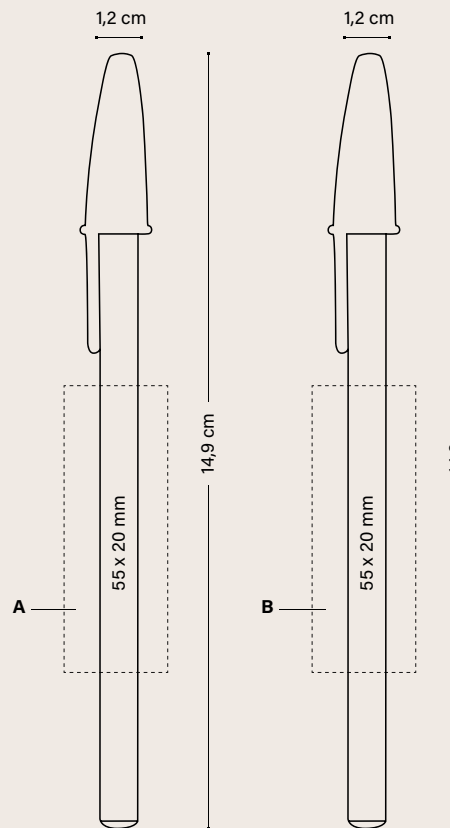

**ENVASE ESPECIAL OPCIONAL**



PLASTIC  
POUCH

+ INFO PÁGS. 222 A 227

**EMBALAJE EXTERIOR**



500 ± 3,5 KG

**ESPECIFICACIONES**



FABRICADO E  
IMPRESO EN  
FABRICAS BIC



CUMPLIMIENTO  
DE LA NORMATIVA



IMPRIM'VERT®



100%  
RECICLABLE

**MODOS DE ESCRITURA**



BOLÍGRAFO M

**TÉCNICAS DE IMPRESIÓN**



SP  
SERIGRAFIA



BIC® ROUND STIC®

**El icónico BIC® Round Stic®  
ofrece un estilo atemporal  
y de calidad.**

**Su diseño clásico  
se identifica fácilmente  
y simboliza la fiabilidad  
a largo plazo.**





¡Icónico BIC® Boy  
y logo BIC®  
en relieve!

**BIC® ROUND STIC®**

1010 Opaco  
Color de tinta  
● ● ●

Tinta roja bajo consulta



*Impresión  
360°*

100%

*Disponible en  
cuerpo blanco*



ESPECIFICACIONES



COLORES PERSONALIZADOS



FABRICADO E IMPRESO EN FÁBRICAS BIC



FABRICADO EN ESPAÑA



CUMPLIMIENTO DE LA NORMATIVA



ISO certified



IMPRIM'VERT®



100% RECICLABLE



100% ELECTRICIDAD DE FUENTES RENOVABLES



BAJO IMPACTO AMBIENTAL

MODOS DE ESCRITURA



BOLÍGRAFO M

TÉCNICAS DE IMPRESIÓN



SP SERIGRAFÍA



DG DIGITAL

Consulta la página 233 para una explicación detallada de los iconos

**BIC® ROUND STIC®**

1010 Frosted

Color de tinta



*Tinta roja bajo consulta*



¡Versión ECO  
y standard al mismo precio!

**ecolutions®**



FABRICADO DE 94%  
DE MATERIAL RECICLADO\*\*

BANDEJAS  
DE FRUTAS  
Y VERDURAS



**BIC® ROUND STIC®**

1E10 Opaco

Color de tinta



Tinta roja bajo consulta



impresión  
360°

100%

**BIC® ROUND STIC®**

1E10 Frosted

Color de tinta



Tinta roja bajo consulta



100%

Disponible en  
cuerpo blanco



ESPECIFICACIONES



MIX &  
MATCH



COLORES  
PERSONALIZADOS



FABRICADO E  
IMPRESO EN  
FÁBRICAS BIC



FABRICADO  
EN ESPAÑA



CUMPLIMIENTO  
DE LA NORMATIVA



IMPRIM'VERT®

ecolutions®



BANDEJAS  
DE FRUTAS  
Y VERDURAS



100%  
RECICLABLE



100% ELECTRICIDAD DE  
FUENTES RENOVABLES



BAJO IMPACTO  
MEDIOAMBIENTAL

MODOS DE  
ESCRITURA



BOLÍGRAFO M

TÉCNICAS DE  
IMPRESIÓN



SP  
SERIGRAFIA



DG  
DIGITAL

\*48h no disponible en acabados digitales

\*\*Porcentaje calculado a partir del peso total del producto excluyendo el cartucho. Debido al contenido reciclado de las primeras materias con las que se fabrica el producto, no podemos garantizar que los colores que aparecen en el catálogo, ni los colores customizados a la carta, tengan siempre el mismo color y apariencia

**BIC® ROUND STIC®**

1010 / **ecolutions®** 1E10 Opaco  
 1010 / **ecolutions®** 1E10 Frosted

Cantidad mínima 500 unidades.  
 Combinación de colores estándar

**ecolutions®**



Combinación de colores estándar\*\*\*

**Botón**

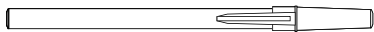

**Capuchón**

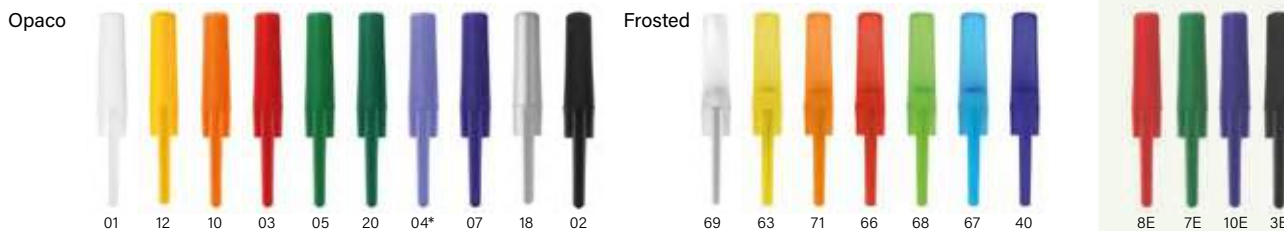
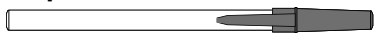

**Sección**

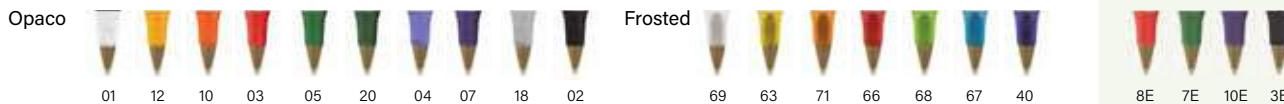

**Cuerpo**



Color exacto: ≥ 10.000 unidades



Añade el Möbius loop a tu arte final sin cargo adicional. Por favor asegúrate de especificarlo en tu pedido. (La impresión del Möbius loop a mano izquierda en la esquina).

\*Hasta que se acabe el stock  
 \*\*48h no disponible en acabados digitales  
 \*\*\*Debido al contenido reciclado de las primeras materias con las que se fabrica el producto, no podemos garantizar que los colores que aparecen en el catálogo, ni los colores customizados a la carta, tengan siempre el mismo color y apariencia



Personalización

**BIC® ROUND STIC®**

1010

ecolutions® 1E10

**A SP:** máx. 3 col.

**B SP:** máx. 1 col.

**C DG:** a todo color

(Solo disponible en cuerpo blanco)

Cantidad mínima 500 unidades.

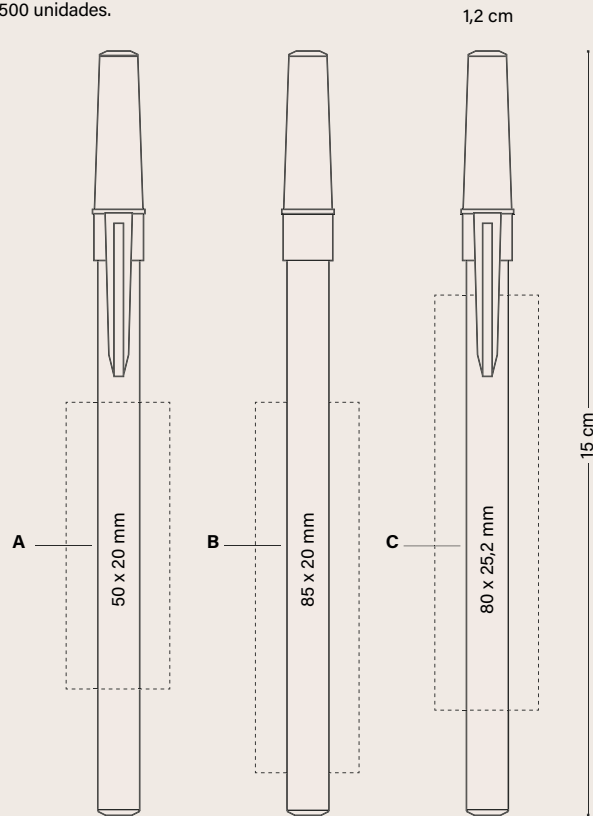

**ENVASE ESPECIAL OPCIONAL**



PLASTIC  
POUCH

+ INFO PÁGS. 222 A 227

**EMBALAJE EXTERIOR**



500 ± 2,5 KG

**ESPECIFICACIONES**



**MODOS DE ESCRITURA**



**TÉCNICAS DE IMPRESIÓN**



Consulta la página 233 para una explicación detallada de los iconos

# BIC® ROUND STIC® BGUARD™ ANTIBACTERIAL

BGUARD™



Protección contra las bacterias



Protección de la superficie del bolígrafo



Protección permanente

ISO 22196

Test protocolo Anti-bacterias



*¡Icónico BIC® Boy y el logo BIC® en relieve!*

ANTIBACTERIAL™

## BIC® ROUND STIC® BGUARD™ ANTIBACTERIAL

1011 Opaco

Color de tinta



Tinta roja bajo consulta



07BG



02BG



03BG



01BG

*impresión 360°*

*Disponible en cuerpo blanco*



MIX & MATCH

Sin cargo extra

Cantidad mínima 500 unidades  
Combinación de colores estándar

### Botón

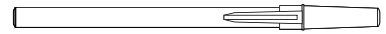

Opaco



### Capuchón

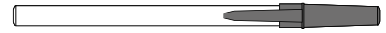

Opaco



### Sección

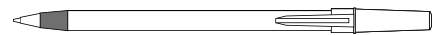

Opaco



### Cuerpo



Opaco

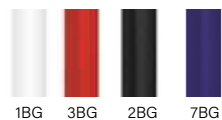

Color exacto: ≥ 10.000 unidades



\*48h no disponible en acabados digitales  
Disponible en una selección de países, pregunta a tu representante de atención al cliente.

Personalización

**BIC® ROUND STIC®  
BGUARD™ ANTIBACTERIAL**  
1011

**A SP:** máx. 2 col.  
**B DG:** a todo color

Cantidad mínima 500 unidades.

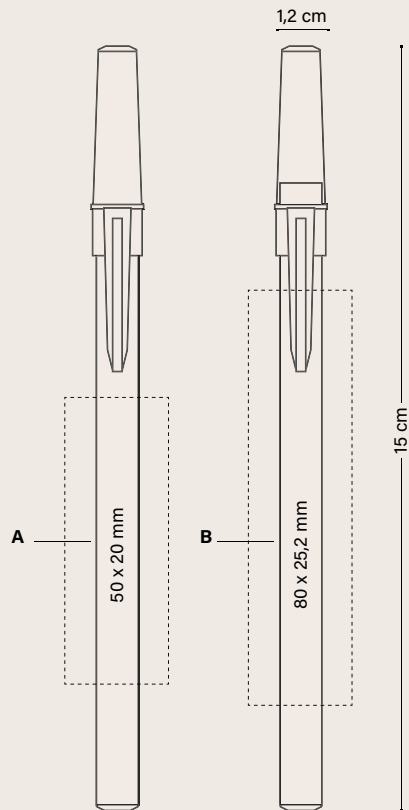

ENVASE ESPECIAL OPCIONAL



PLASTIC  
POUCH

+ INFO PÁGS. 222 A 227

EMBALAJE EXTERIOR



500 ± 2,5 KG

ESPECIFICACIONES



COLORES  
PERSONALIZADOS



FABRICADO E  
IMPRESO EN  
FÁBRICAS BIC



FABRICADO  
EN ESPAÑA



CUMPLIMIENTO  
DE LA NORMATIVA



IMPRIM'VERT®



100%  
RECICLABLE



100% ELECTRICIDAD DE  
FUENTES RENOVABLES



BAJO IMPACTO  
AMBIENTAL

MODOS DE  
ESCRITURA



BOLÍGRAFO M

TÉCNICAS DE  
IMPRESIÓN



SERIGRAFÍA



DIGITAL



*¡Icónico BIC® Boy  
y el logo BIC®  
en relieve!*

## BIC® M10® CLIC

1590

Color de tinta



01

8G

10

14

59

04

02

3D

100%

●  
Solo disponible  
en tinta negra

Personalización

**BIC® M10® CLIC**  
1590

A SP: máx. 2 col.

Cantidad mínima 500 unidades

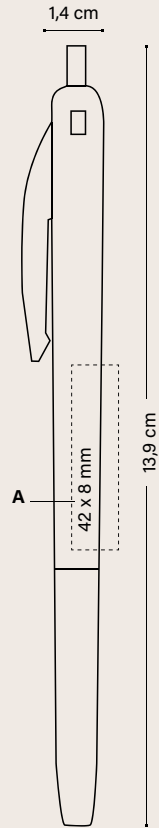

ENVASE ESPECIAL OPCIONAL



+ INFO PÁGS. 222 A 227

EMBALAJE EXTERIOR



ESPECIFICACIONES



MODOS DE ESCRITURA



TÉCNICAS DE IMPRESIÓN



MIRA EL VIDEO

Consulta la página 233 para una explicación detallada de los iconos





# BIC<sup>®</sup> MEDIA CLIC

---

Uno de los más vendidos de la industria, funcional y de diseño reconocido, nuestro BIC<sup>®</sup> Media Clic es un producto duradero disponible en diferentes materiales. Escoge entre el estándar, reciclado, Bio-Based, versión antibacterial y antimicrobial. Inspírate con la gran variedad de acabados y colores para destacar tu marca.

**Ecolutions<sup>®</sup>**

**Grip**

**Grip Ecolutions<sup>®</sup>**

**BGuard<sup>™</sup> Antibacterial**

**BGuard<sup>™</sup> Antimicrobial**

**Bio-Based**

**Bio-Based BGuard<sup>™</sup> Antibacterial**

**Shine**

**Glacé**

**Portaminas**



¡LA SOLUCIÓN PARA UNA COMUNICACIÓN A TODO COLOR!

Ahora en cuerpos de colores



También en portaminas

## BIC® MEDIA CLIC

1025 Bolígrafo  
1028 Portaminas  
Polished

Color de tinta



Tinta roja bajo consulta



←  
¡Más de 10.000 clicks!  
= Mayor visibilidad para tu marca

impresión 360°



¡Icónico BIC® Boy en relieve!



También en portaminas

**BIC® MEDIA CLIC**  
1025 Bolígrafo / 1028 Portaminas  
Frosted

Color de tinta



Tinta roja bajo consulta



ESPECIFICACIONES



FABRICADO EN ESPAÑA



MODOS DE ESCRITURA



TÉCNICAS DE IMPRESIÓN



\* 48h no disponible en acabados digitales  
Portaminas 1028 disponible en: 3B, 63, 71, 39, 67



*¡cónico BIC® Boy  
en relieve!*



*También en  
portaminas*

## **BIC® MEDIA CLIC**

1025 Bolígrafo / 1028 Portaminas

Opaco

Color de tinta



*Tinta roja bajo consulta*



ESPECIFICACIONES



FABRICADO EN ESPAÑA



CUMPLIMIENTO DE LA NORMATIVA



ecolutions®



PIEZAS DE PLÁSTICO DE AUTOMÓVIL



RECICLABLE



100% ELECTRICIDAD DE FUENTES RENOVABLES



BAJO IMPACTO AMBIENTAL

MODOS DE ESCRITURA



BOLÍGRAFO M

TÉCNICAS DE IMPRESIÓN



SERIGRAFÍA



DIGITAL

¡Versión ECO y standard al mismo precio!

ecolutions®



FABRICADO DE 92% DE MATERIAL RECICLADO\*\*\*



PIEZAS DE PLÁSTICO DE AUTOMÓVIL

BIC® MEDIA CLIC

1E25 Bolígrafo

Opaco

Color de tinta



impresión 360°

Disponible en cuerpo blanco



\*Hasta que se acabe el stock

\*\*48h no disponible en acabados digitales

\*\*\*Porcentaje calculado a partir del peso total del producto excluyendo el cartucho. Debido al contenido reciclado de las primeras materias con las que se fabrica el producto, no podemos garantizar que los colores que aparecen en el catálogo, ni los colores customizados a la carta, tengan siempre el mismo color y apariencia



**BIC® MEDIA CLIC**

1025 Bolígrafo

Transparente

Color de tinta



1R\*



4D



92



93



72\*

100%



*También en  
portaminas*

**BIC® MEDIA CLIC GRIP**

1020 Bolígrafo / 1021 Portaminas

Opaco

Color de tinta



01/12

100%

*Disponible en  
cuerpo blanco*



# BIC® MEDIA CLIC GRIP



**BIC® MEDIA CLIC GRIP**  
1020 Bolígrafo / 1021 Portaminas  
Frosted  
Color de tinta  
● ● ●



01/69 69/69 71/69 82/69 40/69 100%



También en portaminas

¡Versión ECO y standard al mismo precio!

**ecolutions®**

FABRICADO DE 92% DE MATERIAL RECICLADO\*\*\*



PIEZAS DE PLÁSTICO DE AUTOMÓVIL

**BIC® MEDIA CLIC GRIP**  
1E20 Bolígrafo / 1E21 Portaminas  
Opaco  
Color de tinta  
● ● ●



01/12 01/03 01/05 01/02 01/07 100%

## ESPECIFICACIONES



**MIX & MATCH**



COLORES PERSONALIZADOS



FABRICADO E IMPRESO EN FÁBRICAS BIC



FABRICADO EN ESPAÑA



CUMPLIMIENTO DE LA NORMATIVA



ISO certified

IMPRIM'VERT®

ecolutions®



PIEZAS DE PLÁSTICO DE AUTOMÓVIL



100% RECICLABLE



100% ELECTRICIDAD DE FUENTES RENOVABLES



BAJO IMPACTO AMBIENTAL

## MODOS DE ESCRITURA



BOLÍGRAFO M

## TÉCNICAS DE IMPRESIÓN



SERIGRAFÍA



DIGITAL

\*\*48h no disponible en acabados digitales

\*\*\*Porcentaje calculado a partir del peso total del producto excluyendo el cartucho. Debido al contenido reciclado de las primeras materias con las que se fabrica el producto, no podemos garantizar que los colores que aparecen en el catálogo, ni los colores customizados a la carta, tengan siempre el mismo color y apariencia

# BIC® MEDIA CLIC BOLÍGRAFO

## BIC® MEDIA CLIC

1025 Bolígrafo / **ecolutions®** 1E25 Bolígrafo

## BIC® MEDIA CLIC GRIP

1020 Bolígrafo / **ecolutions®** 1E20 Bolígrafo



Sin cargo extra

Cantidad mínima 500 unidades

**ecolutions®** Combinación de colores estándar

### Botón

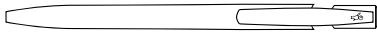

Opaco



Frosted



### Clip

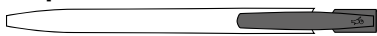

Opaco

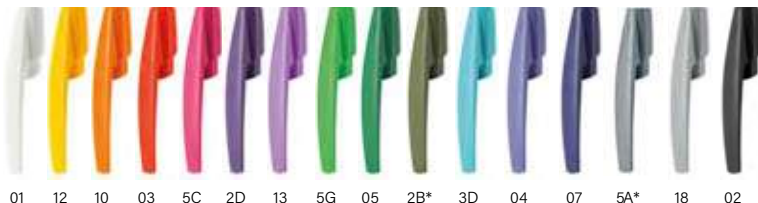

Frosted



### Cuerpo



Opaco

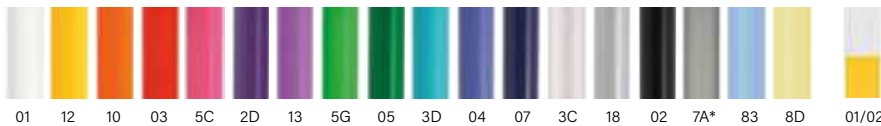

Frosted

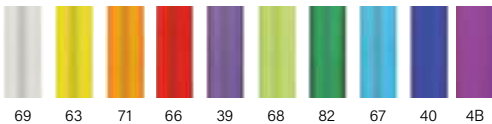

Polished

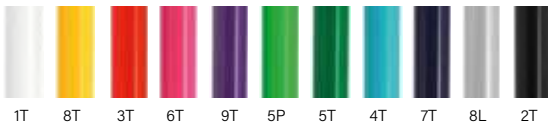

Transparente

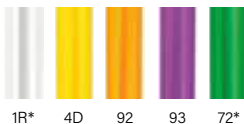

### Cuerpo y Grip

### Cuerpo y Grip

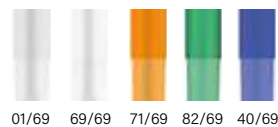

PIEZAS DE PLÁSTICO DE AUTOMÓVIL

Combinación de colores estándar\*\*\*

Opaco



Cuerpo y Grip Opaco



Añade el Möbius loop a tu arte final sin cargo adicional. Por favor asegúrate de especificarlo en tu pedido. (La impresión del Möbius loop a mano izquierda en la esquina).

Color exacto: ≥ 10.000 unidades 1025/1E25

Color exacto: ≥ 20.000 unidades 1020/1E20



**britePix DIGITAL** ¡LA SOLUCIÓN PARA UNA COMUNICACIÓN A TODO COLOR!

#### ESPECIFICACIONES



COLORES PERSONALIZADOS



FABRICADO E IMPRESO EN FÁBRICAS BIC



PIEZAS DE PLÁSTICO DE AUTOMÓVIL



100% RECICLABLE

#### MODOS DE ESCRITURA



BOLÍGRAFO M

#### TÉCNICAS DE IMPRESIÓN



SERIGRAFÍA



DIGITAL

## BIC® MEDIA CLIC

1028 Portaminas

## BIC® MEDIA CLIC GRIP

1021 Portaminas / eColutions® 1E21 Portaminas



Sin cargo extra

Cantidad mínima 500 unidades  
Combinación de colores estándar

### Clip



Opaco

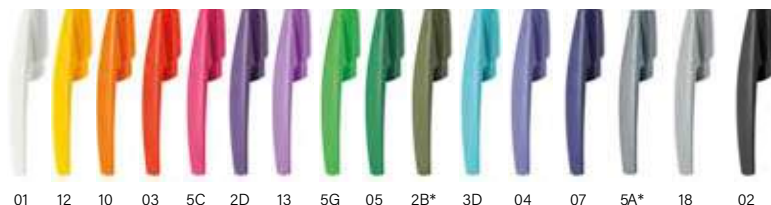

Frosted



01 12 10 03 5C 2D 13 5G 05 2B\* 3D 04 07 5A\* 18 02 69

### Cuerpo



Opaco

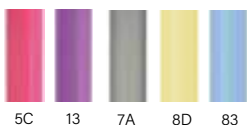

5C 13 7A 8D 83

Frosted

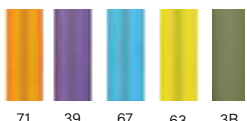

71 39 67 63 3B

Polished



8T 3T 6T 9T 5P 5T

### Cuerpo y Grip



01/02

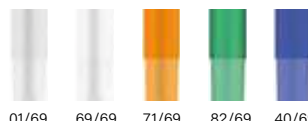

01/69 69/69 71/69 82/69 40/69



¡LA SOLUCIÓN PARA UNA COMUNICACIÓN A TODO COLOR!

Toda la gama de colores disponible en BritePix™ Digital

Color exacto: ≥ 10.000 unidades 1028

Color exacto: ≥ 20.000 unidades 1021 / 1E21



eColutions®



PIEZAS DE PLÁSTICO DE AUTOMÓVIL

Combinación de colores estándar\*\*\*

Cuerpo y Grip

Opaco

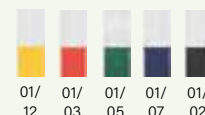

01/12 01/03 01/05 01/07 01/02



Añade el Möbius loop a tu arte final sin cargo adicional. Por favor asegúrate de especificarlo en tu pedido. (La impresión del Möbius loop a mano izquierda en la esquina).

#### ESPECIFICACIONES



COLORES PERSONALIZADOS



FABRICADO E IMPRESO EN FABRICAS BIC



PIEZAS DE PLÁSTICO DE AUTOMÓVIL



100% RECICLABLE

#### MODOS DE ESCRITURA



BOLÍGRAFO M

#### TÉCNICAS DE IMPRESIÓN



SERIGRAFÍA



DIGITAL

## Personalización

### BIC® MEDIA CLIC

1025 Bolígrafo  
1028 Portaminas  
eCOlutions® 1E25 Bolígrafo

A SP: máx. 4 col.

B SP: máx. 2 col.

C DG: a todo color

Cantidad mínima 500 unidades.

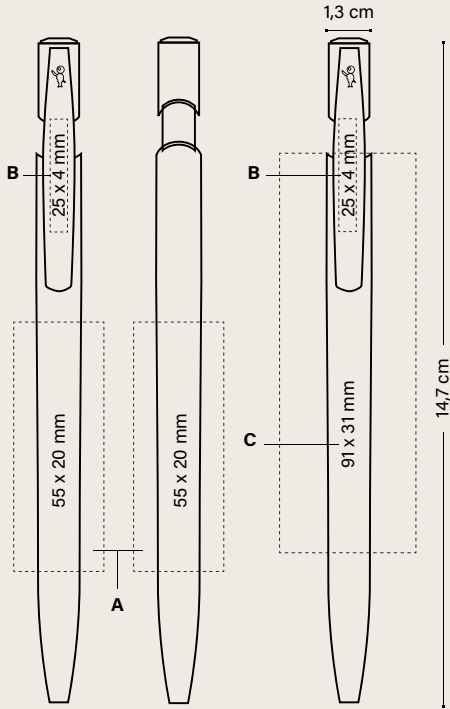

### ENVASE ESPECIAL OPCIONAL



+ INFO PÁGS. 222 A 227

### EMBALAJE EXTERIOR



## Personalización

### BIC® MEDIA CLIC GRIP

1020 Bolígrafo  
1021 Portaminas

eCOlutions® 1E20 Bolígrafo

eCOlutions® 1E21 Portaminas

D SP: máx. 2 col.

E SP: máx. 4 col.

F DG: a todo color

D SP: máx. 4 col.

E SP: máx. 2 col.

Cantidad mínima 500 unidades.

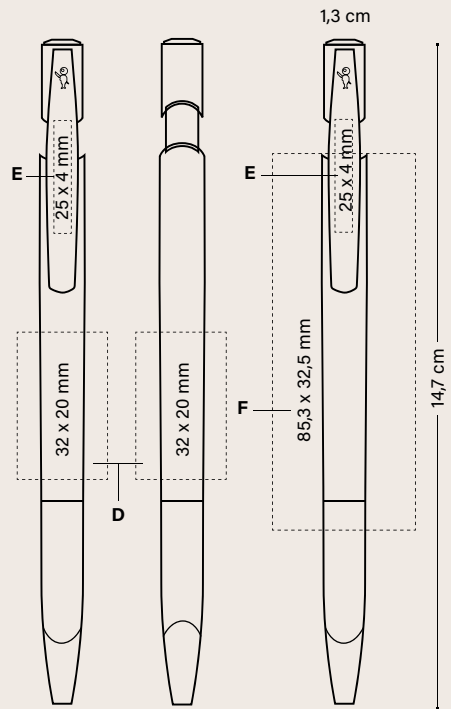

### ENVASE ESPECIAL OPCIONAL



+ INFO PÁGS. 222 A 227

### EMBALAJE EXTERIOR



### ESPECIFICACIONES



FABRICADO E IMPRESO EN FÁBRICAS BIC



PIEZAS DE PLÁSTICO DE AUTOMÓVIL



100% RECICLABLE

### MODOS DE ESCRITURA



BOLÍGRAFO M

### TÉCNICAS DE IMPRESIÓN



SERIGRAFÍA



DIGITAL



BIC® MEDIA CLIC

## Antibacterial



Protección contra las bacterias



Protección de la superficie del bolígrafo



Protección permanente



Test protocolo Anti-bacterias



1E27

1026

# BIC® MEDIA CLIC BGUARD™ ANTIBACTERIAL

BGUARD™



Protección contra las bacterias



Protección de la superficie del bolígrafo



Protección permanente

ISO 22196

Test protocolo Anti-bacterias



¡LA SOLUCIÓN PARA UNA COMUNICACIÓN A TODO COLOR!

## BIC® MEDIA CLIC BGUARD™ ANTIBACTERIAL

1026: logo antibacterial

1027: logo SARS-CoV-2

Opaco

Color de tinta



Tinta roja bajo consulta



1BG

3BG

7BG

2BG



¡Icónico BIC® Boy y logo Antibacterial siempre visible!



ANTIBACTERIAL™

MIX & MATCH

Sin cargo extra

## BIC® MEDIA CLIC BGUARD™ ANTIBACTERIAL

1026: logo antibacterial

1027: logo SARS-CoV-2

Opaco

Cantidad mínima 500 unidades

Combinación de colores estándar

### Botón

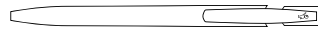

Opaco

1BG

3BG

7BG

2BG

### Clip

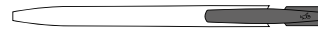

Opaco



1BG

3BG

07BG

2BG

### Cuerpo



Opaco



1BG

3BG

7BG

2BG

Color exacto: ≥ 10.000 unidades



Personalización:

### BIC® MEDIA CLIC BGUARD™ ANTIBACTERIAL

1026: logo antibacterial  
1027: logo SARS-CoV-2

A **SP**: máx. 2 col.  
B **SP**: máx. 1 col.  
C **DG**: a todo color

Cantidad mínima 500 unidades.

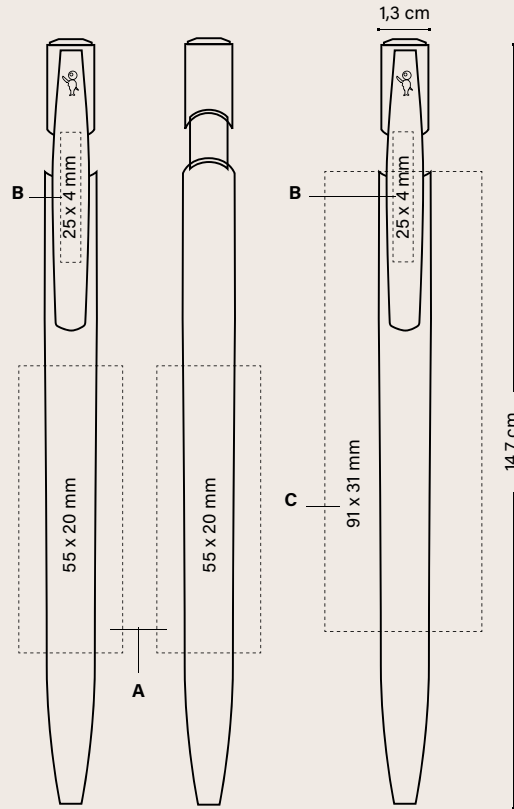

#### ENVASE ESPECIAL OPCIONAL



ECO SLEEVE



PLASTIC POUCH



WINDOW BOX

+ INFO PÁGS. 222 A 227

#### EMBALAJE EXTERIOR



500 ± 4,1 KG

#### ESPECIFICACIONES



#### MODOS DE ESCRITURA



#### TÉCNICAS DE IMPRESIÓN



Consulta la página 233 para una explicación detallada de los iconos

# BIC® MEDIA CLIC BGUARD™ ANTIMICROBIAL ECOLUTIONS®



ANTIMICROBIAL™\* =



Protección contra las bacterias 99% en 24h

+



Reducción viral 93% en 24h

+



Inhibición de hongos 24h

BGUARD™ **ecolutions®**

**MIX & MATCH**

Sin cargo extra

**ecolutions®**

FABRICADO DE 86% DE MATERIAL RECICLADO\*\*

PIEZAS DE PLÁSTICO DE AUTOMÓVIL



## BIC® MEDIA CLIC BGUARD™ ANTIMICROBIAL ECOLUTIONS®

ecolutions® 1E26: logo antimicrobial

ecolutions® 1E27: logo SARS-CoV-2

Opaco

Color de tinta



Tinta roja bajo consulta



**ecolutions®**

PIEZAS DE PLÁSTICO DE AUTOMÓVIL



## BIC® MEDIA CLIC BGUARD™ ANTIMICROBIAL ECOLUTIONS®

ecolutions® 1E26 / ecolutions® 1E27



Añade el Möbius loop a tu arte final sin cargo adicional. Por favor asegúrate de especificarlo en tu pedido. (La impresión del Möbius loop a mano izquierda en la esquina).

Cantidad mínima 500 unidades  
Combinación de colores estándar

### Botón



Opaco

1BG 3BG 7BG 2BG

### Clip

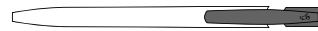

Opaco



1BG 3BG 7BG 2BG

### Cuerpo



Opaco



1E 3E

Color exacto: ≥ 10.000 unidades



También puedes optar por imprimir el logotipo de reducción de SARS-CoV-2. Solicita más información a tu representante de atención al cliente

\*El 99,9% de las bacterias se eliminan de la superficie en 24 horas (y más del 30% en 2 horas).

Probado según el protocolo ISO 22196 adaptado al uso real del bolígrafo.

El 93% de los virus, el coronavirus Sars-Cov-2 que causa la enfermedad Covid-19, se eliminan de la superficie en 24 horas (y alrededor del 50% en 2 horas).

Probado según el protocolo ISO 22196 adaptado al uso real del instrumento de escritura.

Los hongos presentes en la superficie se inhiben en 24 horas.

Probado bajo el protocolo ISO 22196 adaptado a hongos y al uso real del bolígrafo.



Protección de la superficie del bolígrafo



Protección permanente



Test protocolo Anti-bacterias



Adaptado al protocolo de test de hongos



Protocolo de test antiviral

Personalización

**BIC® MEDIA CLIC Bguard™  
ANTIMICROBIAL ECOLUTIONS®**

ecolutions® 1E26: logo antimicrobial

ecolutions® 1E27: logo SARS-CoV-2

A SP: máx. 2 col.

B SP: máx. 2 col.

Cantidad mínima 500 unidades.

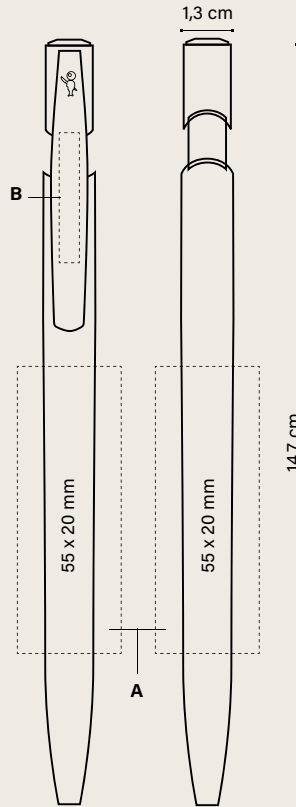

ENVASE ESPECIAL OPCIONAL



ECO SLEEVE



PLASTIC POUCH



WINDOW BOX

+ INFO PÁGS. 222 A 227

EMBALAJE EXTERIOR



500 ± 4,1 KG

ESPECIFICACIONES



MIX & MATCH



COLORES PERSONALIZADOS



FABRICADO E IMPRESO EN FÁBRICAS BIC



FABRICADO EN ESPAÑA



CUMPLIMIENTO DE LA NORMATIVA



IMPRIM'VERT®

ecolutions®



PIEZAS DE PLÁSTICO DE AUTOMÓVIL



RECICLABLE



100% ELECTRICIDAD DE FUENTES RENOVABLES



BAJO IMPACTO AMBIENTAL

MODOS DE ESCRITURA



BOLÍGRAFO M

TÉCNICAS DE IMPRESIÓN



SERIGRAFIA

Consulta la página 233 para una explicación detallada de los iconos

Disponible en una selección de países, pregunta a tu representante de atención al cliente.

\*\*Porcentaje calculado a partir del peso total del producto excluyendo el cartucho. Debido al contenido reciclado de las primeras materias con las que se fabrica el producto, no podemos garantizar que los colores que aparecen en el catálogo, ni los colores customizados a la carta, tengan siempre el mismo color y apariencia



BIC® MEDIA CLIC  
BIO-BASED ECOLUTIONS®

BIO BASED

# La prioridad del ciclo de vida del bolígrafo es la sostenibilidad

Hecho para durar:

- Más de 10.000 clicks
- Mayor visibilidad para tu marca
- Clip resistente a roturas



## BOLÍGRAFO DE ORIGEN BIOLÓGICO

¿No queda tinta en el bolígrafo? No hay problema, es compostable\*.

El cuerpo es **100% Bio-Based**.



## 100 % Electricidad de fuentes renovables

Nuestra fábrica e instalaciones de impresión están alimentadas con electricidad producida **100% a partir de fuentes renovables**.



**TRANSPORTE DE BAJO IMPACTO:** Producción, impresión e incluso la materia prima.



**100% Reciclable**  
Ubicity™

**70% Bio-Based MATERIAL\*\***

**100% Bio-Based COLORANTES**

# BIC® MEDIA CLIC BIO-BASED ECOLUTIONS®



**BIO BASED** FABRICADO EN UN 70% CON MATERIALES BIODEGRADABLES\*\*  
100% COMPOSTABLES INDUSTRIALMENTE

**ecolutions®**

CAÑA DE AZÚCAR

## BIC® MEDIA CLIC BIO-BASED ECOLUTIONS®

1972 Bolígrafo

Opaco

Color de tinta



Tinta roja bajo consulta



Disponible en cuerpo blanco



### ESPECIFICACIONES



MIX & MATCH



COLORES PERSONALIZADOS



FABRICADO E IMPRESO EN FÁBRICAS BIC



FABRICADO EN ESPAÑA



CUMPLIMIENTO DE LA NORMATIVA



IMPRIM'VERT®  
ecolutions®



CAÑA DE AZÚCAR



100% RECICLABLE



100% ELECTRICIDAD DE FUENTES RENOVABLES



BAJO IMPACTO AMBIENTAL

### MODOS DE ESCRITURA



BOLÍGRAFO M

### TÉCNICAS DE IMPRESIÓN



SERIGRAFÍA



DIGITAL

\*\*Porcentaje calculado a partir del peso total del cuerpo del bolígrafo, biodegradable bajo condiciones industriales. Debido al contenido natural de las primeras materias con las que se fabrica el producto, no podemos garantizar que los colores que aparecen en el catálogo, ni los colores customizados a la carta, tengan siempre el mismo color y apariencia.

\*\*\*48h no disponible en acabados digitales

# BIC® MEDIA CLIC BIO-BASED ECOLUTIONS®



Sin cargo extra

## BIC® MEDIA CLIC BIO-BASED ECOLUTIONS®

1972 Bolígrafo Opaco

Cantidad mínima 500 unidades  
Combinación de colores estándar

### Botón

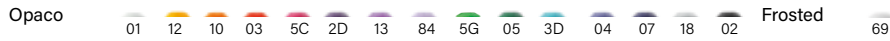

### Clip

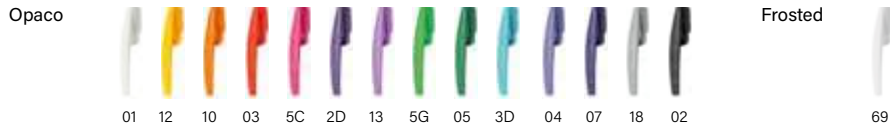

### Cuerpo

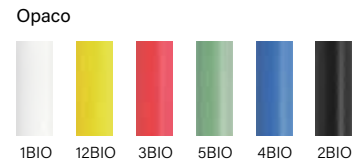

Color exacto:  
≥ 10.000 unidades

### ESPECIFICACIONES



FABRICADO EN ESPAÑA



CAÑA DE AZÚCAR



RECICLABLE

### MODOS DE ESCRITURA



BOLÍGRAFO M

### TÉCNICAS DE IMPRESIÓN



SERIGRAFÍA



DIGITAL

### Personalización

## BIC® MEDIA CLIC BIO-BASED ECOLUTIONS®

1972

**A SP:** máx. 4 col.

**B SP:** máx. 2 col.

**C DG:** a todo color

Cantidad mínima 500 unidades.

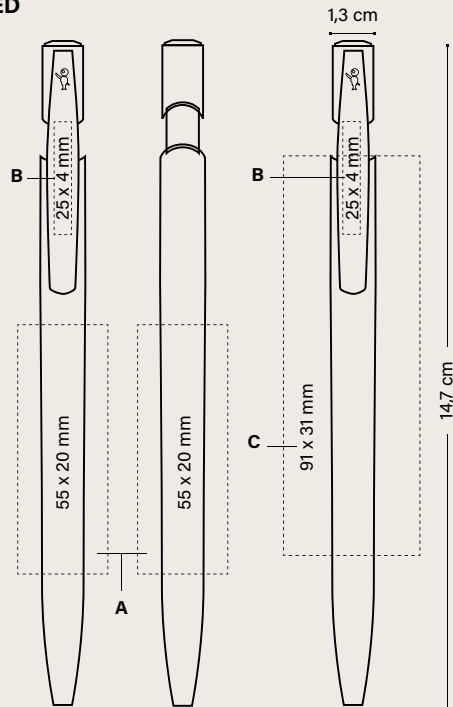

### ENVASE ESPECIAL OPCIONAL



+ INFO PÁGS. 222 A 227



PLASTIC POUCH



WINDOW BOX

### EMBALAJE EXTERIOR



500 ± 4,3KG

Consulta la página 233 para una explicación detallada de los iconos

\*\*Debido al contenido natural de las primeras materias con las que se fabrica el producto, no podemos garantizar que los colores que aparecen en el catálogo, ni los colores customizados a la carta, tengan siempre el mismo color y apariencia.

# BIC® MEDIA CLIC BIO-BASED BGUARD™ ANTIBACTERIAL

BGUARD™



Protección contra las bacterias



Protección de la superficie del bolígrafo



Protección permanente

ISO 22196

Test protocolo Anti-bacterias

BIOBASED



CAÑA DE AZÚCAR

FABRICADO EN UN 70% CON MATERIALES BIODEGRADABLES\*\*  
100% COMPOSTABLES INDUSTRIALMENTE

## BIC® MEDIA CLIC BIO-BASED BGUARD™ ANTIBACTERIAL

1973 Bolígrafo

Opaco

Color de tinta



Tinta roja bajo consulta



impresión 360°

Disponible en cuerpo blanco



### ESPECIFICACIONES



MIX & MATCH



COLORES PERSONALIZADOS



FABRICADO E IMPRESO EN FÁBRICAS BIC



FABRICADO EN ESPAÑA



CUMPLIMIENTO DE LA NORMATIVA



ISO certified



IMPRIM'VERT®



CAÑA DE AZÚCAR



100% RECICLABLE



100% ELECTRICIDAD DE FUENTES RENOVABLES



BAJO IMPACTO AMBIENTAL

### MODOS DE ESCRITURA



BOLÍGRAFO M

### TÉCNICAS DE IMPRESIÓN



SERIGRAFIA



DIGITAL

Consulta la página 233 para una explicación detallada de los iconos

\*48h no disponible en acabados digitales

\*\*Porcentaje calculado a partir del peso total del cuerpo del bolígrafo, biodegradable bajo condiciones industriales. Debido al contenido natural de las primeras materias con las que se fabrica el producto, no podemos garantizar que los colores que aparecen en el catálogo, ni los colores customizados a la carta, tengan siempre el mismo color y apariencia.

# BIC® MEDIA CLIC BIO-BASED BGUARD™ ANTIBACTERIAL

BGUARD™

ecolutions® \*\*



CAÑA DE AZÚCAR

MIX & MATCH

Sin cargo extra

## BIC® MEDIA CLIC BIO-BASED BGUARD™ ANTIBACTERIAL

1973 Bolígrafo Opaco

Cantidad mínima 500 unidades. Combinación de colores estándar.

### Botón

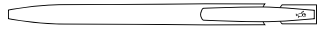

Opaco

01BG 03BG 07BG 02BG

### Clip



Opaco



### Cuerpo



Opaco

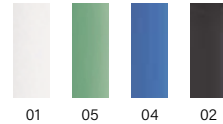

Color exacto: ≥ 10.000 unidades



### ESPECIFICACIONES



48h\*



COLORES PERSONALIZADOS



FABRICADO E IMPRESO EN FABRICAS BIC



FABRICADO EN ESPAÑA

ecolutions®



CAÑA DE AZÚCAR



RECICLABLE

### MODOS DE ESCRITURA



BOLÍGRAFO M

### TÉCNICAS DE IMPRESIÓN



SERIGRAFÍA



DIGITAL

### Personalización

## BIC® MEDIA CLIC BIO-BASED BGUARD™ ANTIBACTERIAL

1973

A SP: máx. 4 col.

B SP: máx. 2 col.

C DG: a todo color

Cantidad mínima 500 unidades.

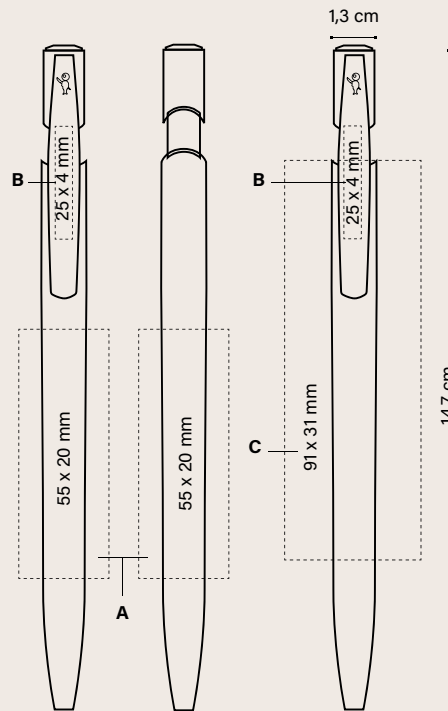

### ENVASE ESPECIAL OPCIONAL



ECO SLEEVE



PLASTIC POUCH



WINDOW BOX

+ INFO PÁGS. 222 A 227

### EMBALAJE EXTERIOR



250 ± 4,3 KG



# BIC® MEDIA CLIC SHINE



## BIC® MEDIA CLIC SHINE 1975 Bolígrafo Opaco

Cantidad mínima 500 unidades. Combinación de colores estándar.

### Botón

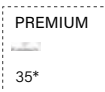
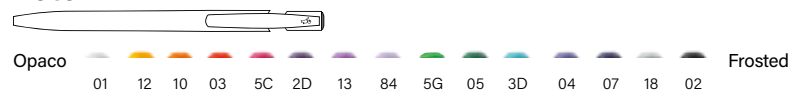

### Clip

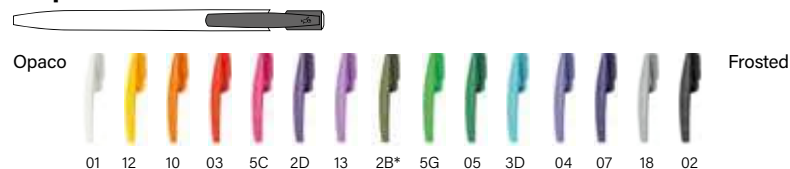

### Cuerpo

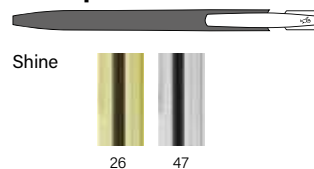

## BIC® MEDIA CLIC SHINE

1975 Bolígrafo Opaco

Color de tinta  
● ● ●

Tinta roja bajo consulta



### BIC® MEDIA CLIC SHINE

1975  
A SP: máx. 2 col.  
B SP: máx. 2 col.  
Cantidad mínima 500 unidades.

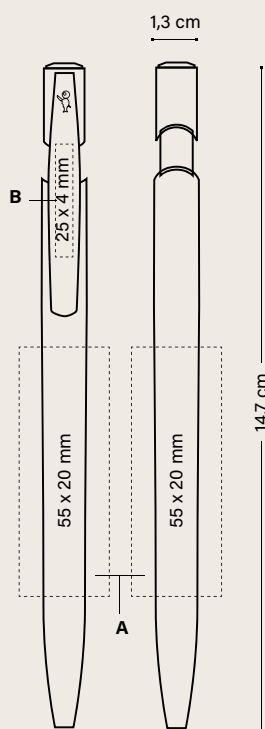

### ENVASE ESPECIAL OPCIONAL



+ INFO PÁGS. 222 A 227

### EMBALAJE EXTERIOR



### ESPECIFICACIONES



Consulta la página 233 para una explicación detallada de los iconos

\*Hasta que se acabe el stock

BIC® MEDIA CLIC GLACÉ

# Colores elegantes en nuestro best seller

---

**BIC® MEDIA CLIC GLACÉ**

1030 Opaco

Color de tinta



Tinta roja bajo consulta



# BIC® MEDIA CLIC GLACÉ



## BIC® MEDIA CLIC GLACÉ

1030 Bolígrafo Opaco

Cantidad mínima 500 unidades  
Combinación de colores estándar

### Botón

Opaco 01 12 10 03 5C 2D 13 84 5G 05 3D 04 07 18 02 Frosted 69

### Clip

Opaco 01 12 10 03 5C 2D 13 2B\* 5G 05 3D 04 07 5A 18 02 Frosted 69

### Cuerpo

Opaco 47G 76 03G 14G 05G 04G

#### Personalización

### BIC® MEDIA CLIC GLACÉ

1030

A SP: máx. 2 col.

B SP: máx. 2 col.

Cantidad mínima 500 unidades.

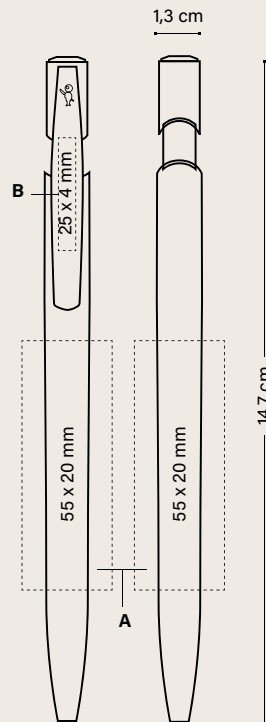

#### ENVASE ESPECIAL OPCIONAL



+ INFO PÁGS. 222 A 227



PLASTIC POUCH



WINDOW BOX

#### EMBALAJE EXTERIOR



500 ± 4,1 KG

#### ESPECIFICACIONES



FABRICADO E IMPRESO EN FABRICAS BIC



FABRICADO EN ESPAÑA



CUMPLIMIENTO DE LA NORMATIVA



IMPRIM'VERT®



RECICLABLE



100% ELECTRICIDAD DE FUENTES RENOVABLES



BAJO IMPACTO AMBIENTAL

#### MODOS DE ESCRITURA



BOLÍGRAFO M

#### TÉCNICAS DE IMPRESIÓN



SERIGRAFÍA

Consulta la página 233 para una explicación detallada de los iconos

BIC® CLIC STIC

**Moderno, flexible, fiable.  
¡Así es BIC® Clic Stic!**

Amplia variedad  
de acabados:  
Digital, Stylus,  
Softfeel®, Mini  
o Antibacterial.

*¡Miles de  
combinaciones  
de colores!*





¡Iconico BIC® Boy en relieve!

**BIC® CLIC STIC**

1000 Opaco

Color de tinta



Disponible en cuerpo blanco



¡Versión ECO y standard al mismo precio!

**ecolutions®**

BANDEJAS DE FRUTAS Y VERDURAS



FABRICADO DE 78% DE MATERIAL RECICLADO\*\*\*

**BIC® CLIC STIC**

1E00 Opaco

Color de tinta



Disponible en cuerpo blanco



ESPECIFICACIONES



**MIX & MATCH**



COLORES PERSONALIZADOS



FABRICADO E IMPRESO EN FABRICAS BIC



FABRICADO EN ESPAÑA



CUMPLIMIENTO DE LA NORMATIVA



**IMPRIM'VERT®**



BANDEJAS DE FRUTAS Y VERDURAS



RECICLABLE



100% ELECTRICIDAD DE FUENTES RENOVABLES



BAJO IMPACTO AMBIENTAL

MODOS DE ESCRITURA



BOLÍGRAFO M

TÉCNICAS DE IMPRESIÓN



SERIGRAFIA



DIGITAL

Consulta la página 233 para una explicación detallada de los iconos

\*Hasta que se acabe el stock

\*\*48h no disponible en acabados digitales

\*\*\*Porcentaje calculado a partir del peso total del cuerpo del bolígrafo. Debido al contenido reciclado de las primeras materias con las que se fabrica el producto, no podemos garantizar que los colores que aparecen en el catálogo, ni los colores customizados a la carta, tengan siempre el mismo color y apariencia.



*¡Versión ECO  
y standard al mismo precio!*

**ecolutions®**



FABRICADO DE  
**78% DE MATERIAL  
RECICLADO\*\***



BANDEJAS DE FRUTAS  
Y VERDURAS

**BIC® CLIC STIC**

1000 Frosted

Color de tinta



Tinta roja bajo consulta



69

63

71

66

68

40

67

100%

*¡Clip  
resistente  
a roturas!*



**BIC® CLIC STIC**

1E00 Frosted

Color de tinta



Tinta roja bajo consulta



2E/8E

2E/10E

2E/3E

2E/7E

100%

**BIC® CLIC STIC**

**SOFTFEEL®**

1005 Opaco

Color de tinta



Tinta roja bajo consulta



20

07

02

100%

**BIC® CLIC STIC SOFTFEEL®**  
1005 Frosted  
Color de tinta  
● ● ●  
Tinta roja bajo consulta



40

**BIC® CLIC STIC STYLUS**  
1847 Opaco  
Color de tinta  
● ● ●  
Tinta roja bajo consulta



01

03

04

18

02

07

**BIC® CLIC STIC STYLUS**  
1846 Opaco  
Color de tinta  
● ● ●  
Tinta roja bajo consulta



1E

3E

¡Versión ECO y standard al mismo precio!

**ecolutions®**  
FABRICADO DE 78% DE MATERIAL RECICLADO\*\*

● ● ●  
BANDEJAS DE FRUTAS Y VERDURAS

ESPECIFICACIONES



MIX & MATCH



COLORES PERSONALIZADOS



FABRICADO E IMPRESO EN FABRICAS BIC



FABRICADO EN ESPAÑA



CUMPLIMIENTO DE LA NORMATIVA



ISO certified



PRIM'VERT®



BANDEJAS DE FRUTAS Y VERDURAS



100% RECICLABLE



100% ELECTRICIDAD DE FUENTES RENOVABLES



BAJO IMPACTO AMBIENTAL

MODOS DE ESCRITURA



BOLÍGRAFO M

TÉCNICAS DE IMPRESIÓN



SP SERIGRAFIA



DG DIGITAL

\*48h no disponible en acabados digitales

\*\*Porcentaje calculado a partir del peso total del cuerpo del bolígrafo. Debido al contenido reciclado de las primeras materias con las que se fabrica el producto, no podemos garantizar que los colores que aparecen en el catálogo, ni los colores customizados a la carta, tengan siempre el mismo color y apariencia

## ESPECIFICACIONES



**MIX & MATCH**



COLORES PERSONALIZADOS



FABRICADO E IMPRESO EN FÁBRICAS BIC



FABRICADO EN ESPAÑA



CUMPLIMIENTO DE LA NORMATIVA



IMPRIM'VERT®



BANDEJAS DE FRUTAS Y VERDURAS



RECICLABLE



100% ELECTRICIDAD DE FUENTES RENOVABLES



BAJO IMPACTO AMBIENTAL

## MODOS DE ESCRITURA



BOLÍGRAFO M

## TÉCNICAS DE IMPRESIÓN



SERIGRAFÍA



DIGITAL

### BIC® CLIC STIC MINI

1892 Opaco

Color de tinta



Tinta roja bajo consulta

### BIC® CLIC STIC MINI

1892 Frosted

Color de tinta



Tinta roja bajo consulta



Disponible en cuerpo blanco



**BIC® CLIC STIC**

1000 Opaco / **ecolutions®** 1E00 Opaco  
 1000 Frosted / **ecolutions®** 1E00 Frosted  
 1005 Opaco / Frosted

Cantidad mínima 500 unidades. Combinación de colores estándar

**BIC® CLIC STIC STYLUS**

1846 / 1847 Opaco

**BIC® CLIC STIC MINI**

1892 Opaco / Frosted



**Botón**

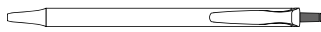

Opaco

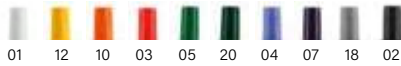

Frosted

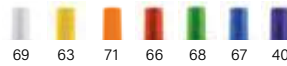

**Clip**

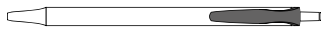

Opaco

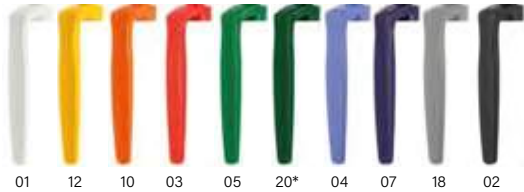

Frosted

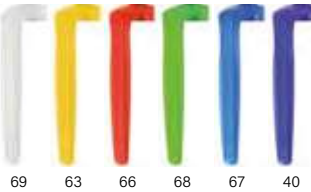

**Sección**

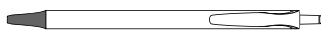

Opaco



Frosted

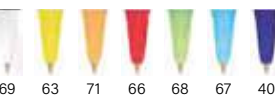

**Stylus**

Opaco



**Cuerpo**



Opaco

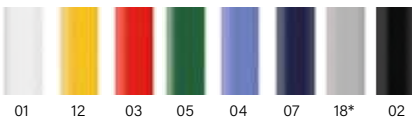

**Stylus**

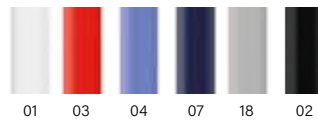

**Softfeel®**

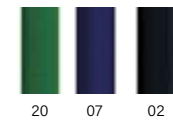

**Mini**



Frosted

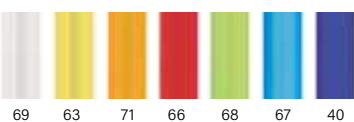

Opaco



Frosted



Color exacto: ≥ 10.000 unidades



Cantidad mínima 500 unidades  
**ecolutions®** Combinación de colores estándar\*\*



Añade el Möbius loop a tu arte final sin cargo adicional. Por favor asegúrate de especificarlo en tu pedido. (La impresión del Möbius loop a mano izquierda en la esquina).

BANDEJAS DE FRUTAS Y VERDURAS



**Botón**



Opaco



**Sección**



Opaco



**Clip**



Opaco

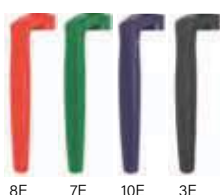

**Cuerpo**



Opaco

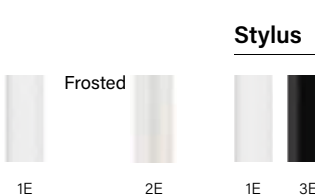

**Stylus**

Frosted



Color exacto: ≥ 10.000 unidades

\*Hasta que se acabe el stock

\*\*Debido al contenido reciclado de las primeras materias con las que se fabrica el producto, no podemos garantizar que los colores que aparecen en el catálogo, ni los colores customizados a la carta, tengan siempre el mismo color y apariencia.

## ESPECIFICACIONES



**MIX & MATCH**



COLORES PERSONALIZADOS



FABRICADO E IMPRESO EN FÁBRICAS BIC



FABRICADO EN ESPAÑA



CUMPLIMIENTO DE LA NORMATIVA



IMPRIM'VERT®



BANDEJAS DE FRUTAS Y VERDURAS



100% RECICLABLE



100% ELECTRICIDAD DE FUENTES RENOVABLES



BAJO IMPACTO AMBIENTAL

## MODOS DE ESCRITURA



BOLÍGRAFO M

## TÉCNICAS DE IMPRESIÓN



SERIGRAFÍA



DIGITAL

## Personalización

### BIC® CLIC STIC

1000 / eColutions® 1E00

### BIC® CLIC STIC STYLUS

1847 / eColutions® 1846

**A SP:** máx. 3 col.

**B SP:** máx. 1 col.

**C SP:** máx. 2 col.

**D DG:** a todo color (área para texto)  
(Solo disponible en cuerpo blanco)

Cantidad mínima 500 unidades.

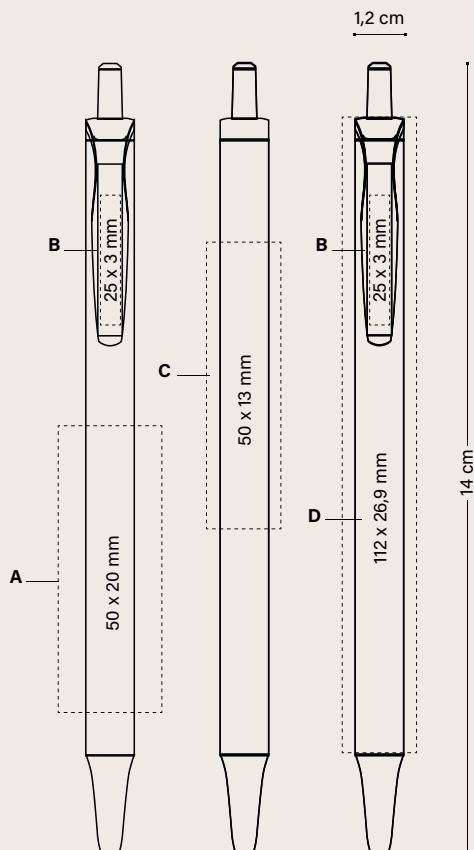

## ENVASE ESPECIAL OPCIONAL



+ INFO PÁGS. 222 A 227



## EMBALAJE EXTERIOR



500 ± 2,9 KG



Personalización

**BIC® CLIC STIC SOFTFEEL®**  
1005

A/B SP: máx. 1 col.

Cantidad mínima 500 unidades.

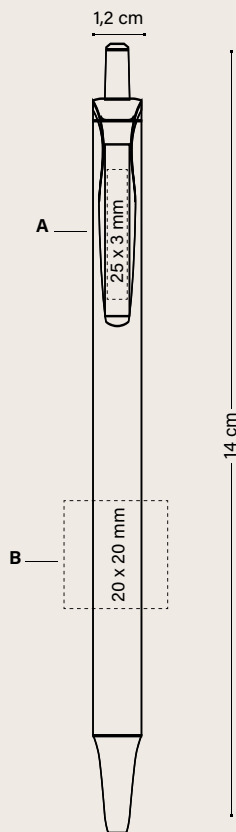

ENVASE ESPECIAL OPCIONAL



+ INFO PÁGS. 222 A 227

EMBALAJE EXTERIOR



Personalización

**BIC® CLIC STIC MINI**  
1892

A SP: máx. 1 col.

B SP: máx. 1 col.

C DG: a todo color (área para texto)  
(Solo disponible en cuerpo blanco)

Cantidad mínima 500 unidades.

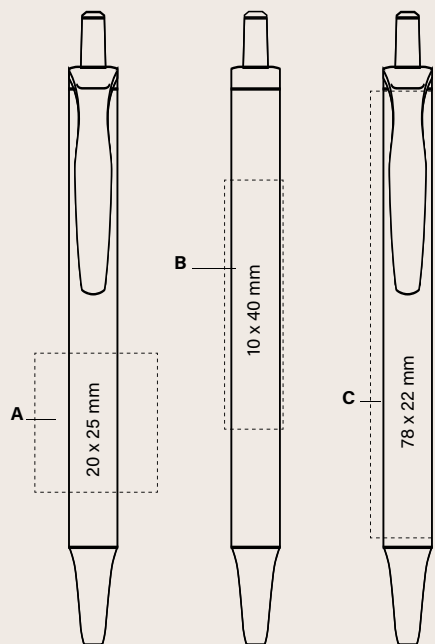

ENVASE ESPECIAL OPCIONAL



+ INFO PÁGS. 222 A 227

EMBALAJE EXTERIOR



ESPECIFICACIONES



MODOS DE ESCRITURA



TÉCNICAS DE IMPRESIÓN



Consulta la página 233 para una explicación detallada de los iconos

# BIC® CLIC STIC BGUARD™ ANTIBACTERIAL

BGUARD™



Protección contra las bacterias



Protección de la superficie del bolígrafo



Protección permanente



Test protocolo Anti-bacterias



¡Leñico BIC® Boy y logo Antibacterial siempre visible!

ANTIBACTERIAL™

## BIC® CLIC STIC BGUARD™ ANTIBACTERIAL

1001 Opaco

Color de tinta



Tinta roja bajo consulta



7BG

2BG

3BG

100%  
01BG

impresión 360°

MIX & MATCH

Sin cargo extra

## BIC® CLIC STIC BGUARD™ ANTIBACTERIAL

1001 Opaco

Cantidad mínima 500 unidades.

Combinación de colores estándar

### Botón



Opaco



### Clip

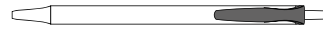

Opaco



### Sección

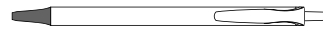

Opaco



### Cuerpo



Opaco

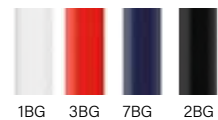

Color exacto: ≥ 10.000 unidades



Disponible en cuerpo blanco



Personalización

**BIC® CLIC STIC BGuard™  
ANTIBACTERIAL**

1001

**A SP:** máx. 2 col.

**B SP:** máx. 1 col.

**C DG:** a todo color

Cantidad mínima 500 unidades.

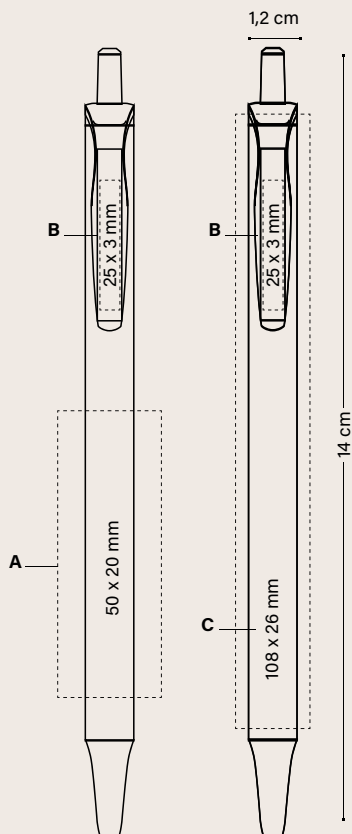

ENVASE ESPECIAL OPCIONAL



ECO SLEEVE

+ INFO PÁGS. 222 A 227



PLASTIC POUCH

EMBALAJE EXTERIOR



500 ± 2,9 KG

ESPECIFICACIONES



MODOS DE ESCRITURA



BOLÍGRAFO M

TÉCNICAS DE IMPRESIÓN



SERIGRAFÍA



DIGITAL

Consulta la página 233 para una explicación detallada de los iconos

# BIC® CLIC STIC STYLUS BGUARD™ ANTIBACTERIAL

BGUARD™



Protección contra las bacterias



Protección de la superficie del bolígrafo



Protección permanente



Test protocolo Anti-bacterias



¡Icónico BIC® Boy y logo Antibacterial siempre visible!

ANTIBACTERIAL™

## BIC® CLIC STIC STYLUS BGUARD™ ANTIBACTERIAL

1848 Opaco

Color de tinta



Tinta roja bajo consulta

¡El primer bolígrafo Stylus antibacterial!

MIX & MATCH

Sin cargo extra



3BG

7BG

2BG

100%  
1BG

impresión 360°



Disponible en cuerpo blanco



## BIC® CLIC STIC STYLUS BGUARD™ ANTIBACTERIAL

1848 Opaco

Cantidad mínima 500 unidades  
Combinación de colores estándar

### Botón



Opaco



### Clip



Opaco



### Sección



Stylus

Opaco



### Cuerpo



Opaco

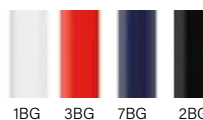

Color exacto: ≥ 10.000 unidades



Personalización

**BIC® CLIC STIC STYLUS  
BGUARD™ ANTIBACTERIAL**

1848

**A SP:** máx. 2 col.

**B SP:** máx. 1 col.

**C DG:** a todo color

(Solo disponible en cuerpo blanco)

Cantidad mínima 500 unidades.

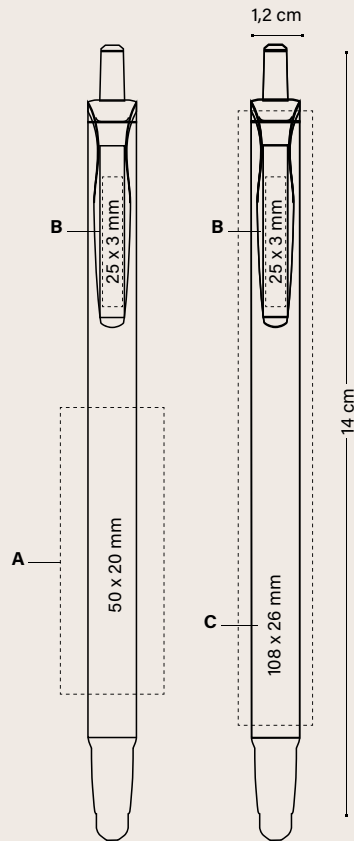

ENVASE ESPECIAL OPCIONAL



+ INFO PÁGS. 222 A 227



EMBALAJE EXTERIOR



ESPECIFICACIONES



FABRICADO E IMPRESO EN FABRICAS BIC



FABRICADO EN ESPAÑA



CUMPLIMIENTO DE LA NORMATIVA



ISO certified



IMPRIM'VERT®



100% RECICLABLE



100% ELECTRICIDAD DE FUENTES RENOVABLES



BAJO IMPACTO AMBIENTAL

MODOS DE ESCRITURA



BOLIÓGRAFO M

TÉCNICAS DE IMPRESIÓN



SP SERIGRAFÍA



DG DIGITAL

Consulta la página 233 para una explicación detallada de los iconos







# BIC<sup>®</sup> SUPER CLIP

---

Descubre el llamativo clip y su mecanismo giratorio suave. La gran área de marcaje XXL ofrece una amplia variedad de posibilidades de personalización en la versión estándar, advance y antibacterial. Ahora también en las versiones soft y glacé.

Además, el BIC<sup>®</sup> Super Clip Origin es el primer bolígrafo de una nueva etapa más innovadora y sostenible. ¡Bienvenidos al futuro!

**Ecolutions<sup>®</sup>**

**BGuard<sup>™</sup> Antibacterial**

**Advance**

**Glacé**

**Glacé Advance**

**Soft**

**Soft Advance**

**Origin**

# BIC® SUPER CLIP

## BIC® SUPER CLIP

1039 Opaco  
Color de tinta



¡Área de  
marcaje  
XXL!



Disponible en  
cuerpo blanco



¡Versión ECO  
y standard al mismo precio!

**ecolutions®**



FABRICADO DE 78%  
DE MATERIAL RECICLADO\*\*\*



PIEZAS DE PLÁSTICO  
DE AUTOMÓVIL

**BIC® SUPER CLIP**

1E50 Opaco

Color de tinta



1E

100%

**BIC® SUPER CLIP**

1039 Transparente

Color de tinta



51



87



86



89



88

100%

ESPECIFICACIONES



COLORES  
PERSONALIZADOS



FABRICADO E  
IMPRESO EN  
FÁBRICAS BIC



FABRICADO EN ESPAÑA



CUMPLIMIENTO  
DE LA NORMATIVA



IMPRIM'VERT®  
ecolutions®



PIEZAS DE  
PLÁSTICO  
DE AUTOMÓVIL



RECICLABLE



100% ELECTRICIDAD DE  
FUENTES RENOVABLES



BAJO IMPACTO  
AMBIENTAL

MODOS DE  
ESCRITURA



BOLÍGRAFO M

TÉCNICAS DE  
IMPRESIÓN



SERIGRAFIA



DIGITAL



BRITEPIX™  
BRITEPIX™ TEXTURE  
BRITEPIX™  
PERSONALISATION

\*\*48h no disponible en acabados digitales

\*\*\*Porcentaje calculado a partir del peso total del producto excluyendo el cartucho. Debido al contenido reciclado de las primeras materias con las que se fabrica el producto, no podemos garantizar que los colores que aparecen en el catálogo, ni los colores customizados a la carta, tengan siempre el mismo color y apariencia.

# BIC® SUPER CLIP

## BIC® SUPER CLIP

1039 Opaco

ecolutions® 1E50 Opaco

1039 Transparente

Cantidad mínima 250 unidades  
Combinación de colores estándar

**MIX &  
MATCH**

Sin cargo extra

### Clip



Opaco

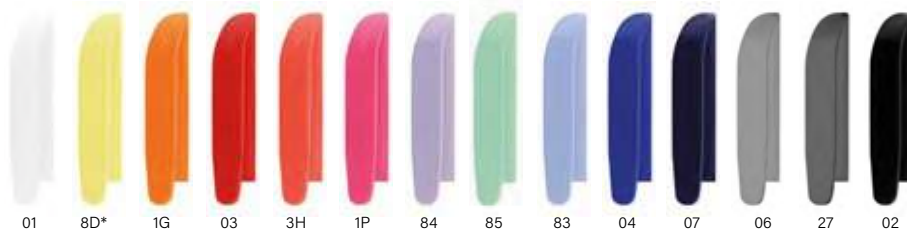

Transparente

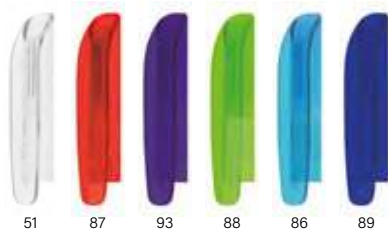

ecolutions®



PIEZAS DE PLÁSTICO  
DE AUTOMÓVIL

Combinación de  
colores estándar \*\*



Añade el Möbius loop a tu arte final sin cargo adicional. Por favor asegúrate de especificarlo en tu pedido. (La impresión del Möbius loop a mano izquierda en la esquina).

### Cuerpo



Opaco

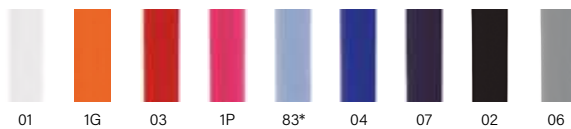

Transparente

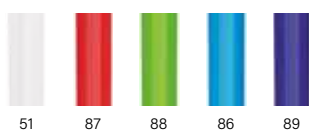

Color exacto: ≥ 10.000 unidades



Personalización

**BIC® SUPER CLIP**

1039

**ecolutions®** 1E50

**A SP:** máx. 2 col.

**B SP:** máx. 1 col.

1039

**C DG:** a todo color

**D BP:** a todo color

**BP Texture:** a todo color

Cantidad mínima 250 unidades.

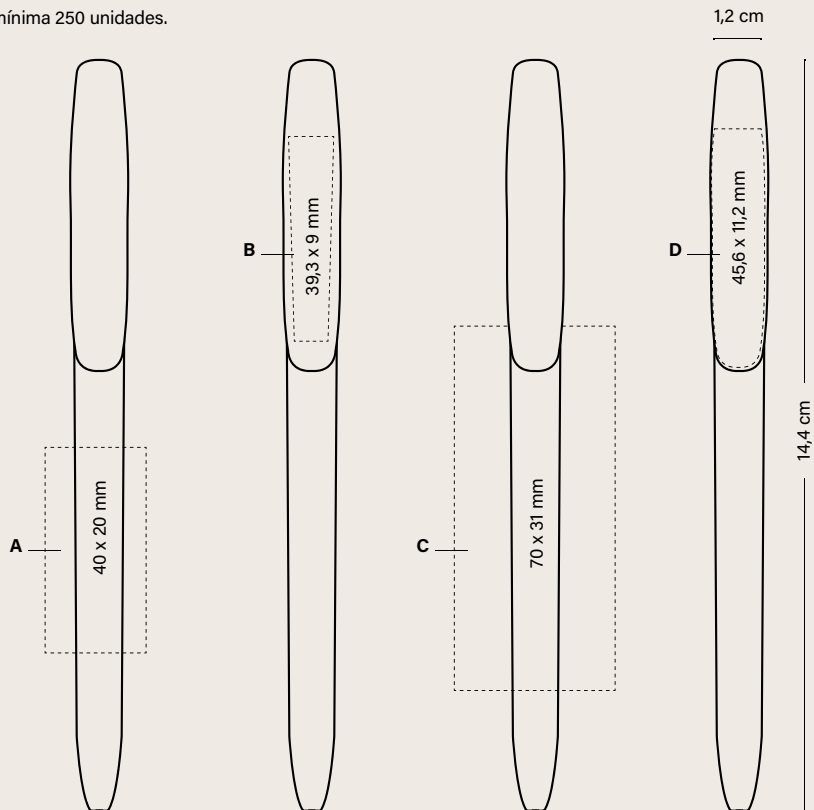

ENVASE ESPECIAL OPCIONAL



+ INFO PÁGS. 222 A 227

EMBALAJE EXTERIOR



¡Nueva!  
*Collection Box*  
(1, 2 y 3 unidades)

250 ± 2,6 KG

ESPECIFICACIONES



100% ELECTRICIDAD DE FUENTES RENOVABLES



BAJO IMPACTO AMBIENTAL

MODOS DE ESCRITURA



BOLIgrafo M

TÉCNICAS DE IMPRESIÓN



SERIGRAFIA



DIGITAL



BRITEPIX™

BRITEPIX™ TEXTURE  
BRITEPIX™ PERSONALISATION

Consulta la página 233 para una explicación detallada de los iconos

# BIC® SUPER CLIP BGUARD™ ANTIBACTERIAL

BGUARD™



Protección contra las bacterias



Protección de la superficie del bolígrafo



Protección permanente

ISO 22196

Test protocolo Anti-bacterias

MIX & MATCH

Sin cargo extra

## BIC® SUPER CLIP BGUARD™ ANTIBACTERIAL

1040 Opaco

Color de tinta



1BG

3BG

7BG

2BG

100%

## BIC® SUPER CLIP BGUARD™ ANTIBACTERIAL

1040 Opaco

Cantidad mínima 250 unidades  
Combinación de colores estándar

### Clip

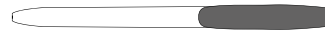

Opaco



1BG 3BG 7BG 2BG

### Cuerpo



Opaco



1BG 3BG 7BG 2BG

Color exacto: ≥ 10.000 unidades



ANTIBACTERIAL™

*¡Logo Antibacterial siempre visible!*



Personalización

**BIC® SUPER CLIP  
BGUARD™ ANTIBACTERIAL**

1040

A/B SP: máx. 1 col.

Cantidad mínima 250 unidades.

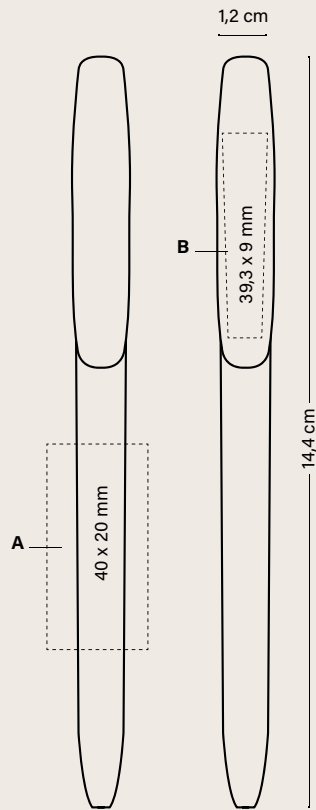

ENVASE ESPECIAL OPCIONAL



ECO SLEEVE



PLASTIC POUCH



WINDOW BOX



COLLECTION BOX

*¡Nueva!  
Collection Box  
(1, 2 y 3 unidades)*



250 ± 2,6 KG

+ INFO PÁGS. 222 A 227

EMBALAJE EXTERIOR

ESPECIFICACIONES



MODOS DE ESCRITURA



TÉCNICAS DE IMPRESIÓN



Consulta la página 233 para una explicación detallada de los iconos

## BIC® SUPER CLIP ADVANCE

1073 Opaco

Color de tinta



*¡Escoge entre 3  
acabados de sección  
metálica!*

*¡Sección metálica!*



35

26

97

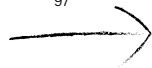

03



1G



04



07

*Servicio de  
recarga bajo  
petición*



06

02

1P

01



Disponible en cuerpo blanco



ESPECIFICACIONES



COLORES PERSONALIZADOS



FABRICADO E IMPRESO EN FÁBRICAS BIC



FABRICADO EN ESPAÑA



CUMPLIMIENTO DE LA NORMATIVA



IMPRIM'VERT®



100% RECYCLABLE



100% ELECTRICIDAD DE FUENTES RENOVABLES



BAJO IMPACTO AMBIENTAL

MODOS DE ESCRITURA



BOLÍGRAFO M

TÉCNICAS DE IMPRESIÓN



SP SERIGRAFÍA



DG DIGITAL



BRITEPIX™  
BRITEPIX™ TEXTURE  
BRITEPIX™ PERSONALISATION

Consulta la página 233 para una explicación detallada de los iconos

# BIC® SUPER CLIP ADVANCE

## BIC® SUPER CLIP ADVANCE

1073 Opaco

Cantidad mínima 250 unidades  
Combinación de colores estándar

**MIX &  
MATCH**

Sin cargo extra

### Clip



Opaco



01 1G 03 1P 04 07 06 02

Transparente



51 87 93 88 86 89

### Cuerpo



Opaco



01 1G 03 1P 04 07 06 02

### Sección



35 26 97

Color exacto:  $\geq 10.000$  unidades



Personalización

**BIC® SUPER CLIP ADVANCE**

1073

**A SP:** máx. 2 col.

**B SP:** máx. 1 col.

**C DG:** a todo color

**D BP:** a todo color

**BP Texture:** a todo color

Cantidad mínima 250 unidades.

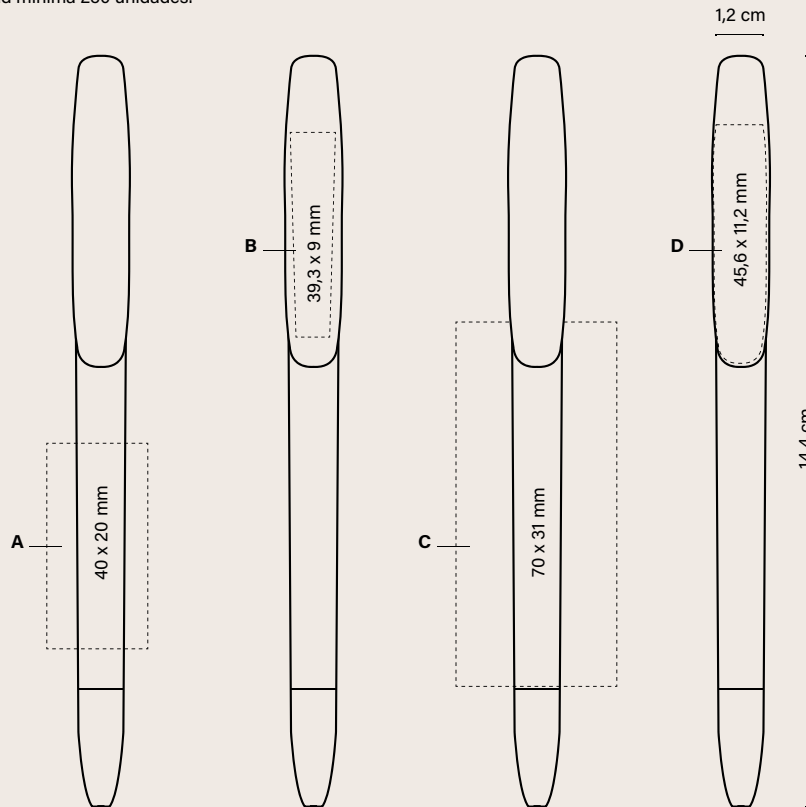

**ENVASE ESPECIAL OPCIONAL**



ECO SLEEVE



PLASTIC POUCH



WINDOW BOX



COLLECTION BOX

*¡Nueva!  
Collection Box  
(1, 2 y 3 unidades)*



250 ± 2,6 KG

+ INFO PÁGS. 222 A 227

**EMBALAJE EXTERIOR**

**ESPECIFICACIONES**



**MODOS DE ESCRITURA**



BOLÍGRAFO M

**TÉCNICAS DE IMPRESIÓN**



SERIGRAFÍA



DIGITAL



BRITEPIX™

BRITEPIX™ TEXTURE

BRITEPIX™ PERSONALISATION

Consulta la página 233 para una explicación detallada de los iconos

¡NUEVO!

BIC® SUPER CLIP GLACÉ & ADVANCE

# Descubre el BIC® Super Clip en su nueva versión más glamurosa.

## BIC® SUPER CLIP GLACÉ

1082

Color de tinta



47G 76 014G 03G 04G 05G

## BIC® SUPER CLIP GLACÉ ADVANCE

1084

Color de tinta



47G/35 05G/35 014G/35 03G/35 04G/35 76/35

Servicio de recarga bajo petición

Disponibles en 3 acabados: plata, oro y rosa



35 26 97



# BIC® SUPER CLIP GLACÉ & ADVANCE

## Sección

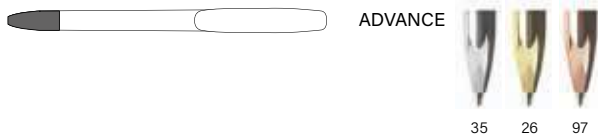

### Personalización

**BIC® SUPER CLIP GLACÉ**  
1082

**BIC® SUPER CLIP GLACÉ  
ADVANCE**  
1084

**A SP:** máx. 2 col.  
**B SP:** máx. 1 col.

Cantidad mínima 250 unidades  
Combinación de colores estándar

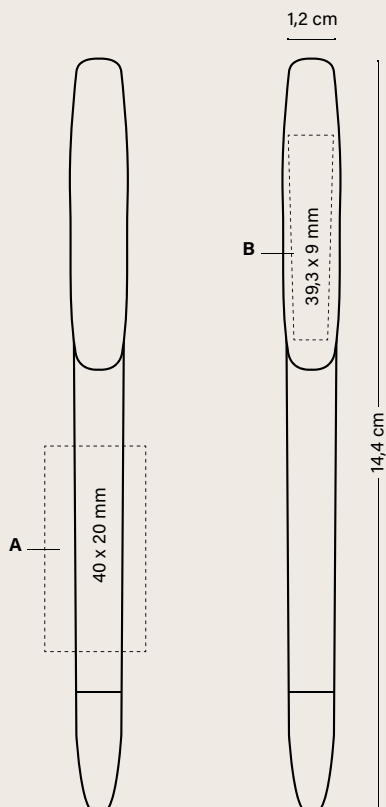

### ESPECIFICACIONES



FABRICADO E IMPRESO EN FABRICAS BIC



FABRICADO EN EUROPA



CUMPLIMIENTO DE LA NORMATIVA



ISO certified



IMPRIM'VERT®



100% RECICLABLE



100% ELECTRICIDAD DE FUENTES RENOVABLES



BAJO IMPACTO AMBIENTAL

### MODOS DE ESCRITURA



BOLIÓGRAFO M

### TÉCNICAS DE IMPRESIÓN



SP SERIGRAFÍA

### ENVASE ESPECIAL OPCIONAL



+ INFO PÁGS. 222 A 227

### EMBALAJE EXTERIOR



250 ± 2,6 KG

*¡Nueva!  
Collection Box  
(1, 2 y 3 unidades)*



MIRA EL VIDEO

Consulta la página 233 para una explicación detallada de los iconos

¡NUEVO!

BIC® SUPER CLIP SOFT & ADVANCE

Aprecia el increíble tacto de seda de nuestro nuevo BIC® Super Clip con mecanismo giratorio.



BIC® SUPER CLIP SOFT

1083

Color de tinta



02F

03F

07F

BIC® SUPER CLIP SOFT

ADVANCE

1085

Color de tinta



02F/35

03F/35

07F/35

*Servicio de recarga bajo petición*

*Disponibles en 3 acabados: plata, oro y rosa*



35

26

97

# BIC® SUPER CLIP SOFT & ADVANCE

## Sección

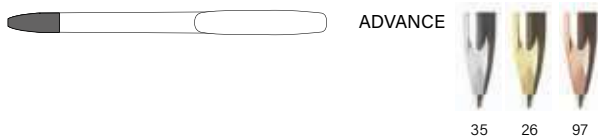

### Personalización

**BIC® SUPER CLIP SOFT**  
1083

**BIC® SUPER CLIP SOFT  
ADVANCE**  
1085

A SP: máx. 1 col.

Cantidad mínima 250 unidades  
Combinación de colores estándar

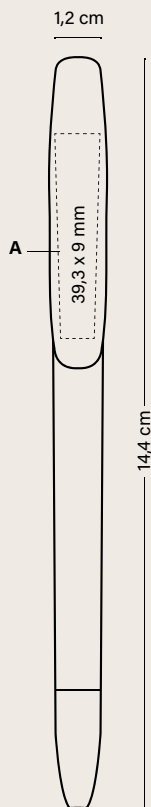

### ENVASE ESPECIAL OPCIONAL



ECO SLEEVE



PLASTIC POUCH



WINDOW BOX



COLLECTION BOX

*¡Nueva!  
Collection Box  
(1, 2 y 3 unidades)*



250 ± 2,6 KG

+ INFO PÁGS. 222 A 227

### ESPECIFICACIONES



FABRICADO EN EUROPA



CUMPLIMIENTO DE LA NORMATIVA



IMPRIM'VERT®



RECICLABLE



100% ELECTRICIDAD DE FUENTES RENOVABLES



BAJO IMPACTO AMBIENTAL

### MODOS DE ESCRITURA



BOLÍGRAFO M

### TÉCNICAS DE IMPRESIÓN



SERIGRAFIA



MIRA EL VÍDEO

Consulta la página 233 para una explicación detallada de los iconos

¡NUEVO!

BIC® SUPER CLIP ORIGIN

# Nuestro nuevo BIC® Super Clip está hecho de materiales naturales.

ecolutions®

FABRICADO CON UN MATERIAL  
DE ORIGEN BIOLÓGICO\*\*

BIC® SUPER CLIP ORIGIN

1038

Color de tinta



ORIGIN <sup>BIO</sup><sub>BASED</sub>

BIC® Super Clip Origin está fabricado con un material de origen biológico compuesto de polímeros naturales excluyendo petróleo, aceite y energía fósil\*.



Aceite de ricino de origen biológico



Serrín de madera  
De bosques europeos gestionados de forma sostenible



Talco  
Extraído en Europa



Fabricado e impreso en fábricas alimentadas con **electricidad 100% renovable.**



**Cuerpo y clip de origen biológico 100%.**



Gracias al programa **UBICUITY™** los instrumentos de escritura de BIC® son **100% reciclables.**



Fabricado en Europa, **bajo impacto en transporte.**

¡Mecanismo giratorio suave!

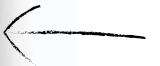

# BIC® SUPER CLIP ORIGIN

## Personalización

### BIC® SUPER CLIP ORIGIN

1038

A SP: máx. 1 col.

Cantidad mínima 250 unidades  
Combinación de colores estándar

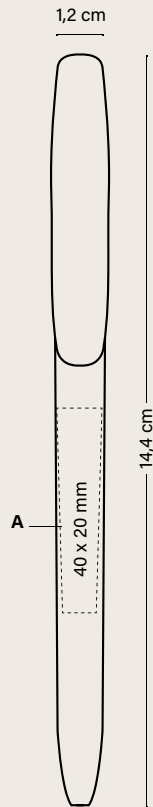

## ENVASE ESPECIAL OPCIONAL



ECO SLEEVE



PLASTIC POUCH



WINDOW BOX



COLLECTION BOX

¡Nueva!  
Collection Box  
(1, 2 y 3 unidades)

## EMBALAJE EXTERIOR



250 ± 2,6 KG

+ INFO PÁGS. 222 A 227

## ESPECIFICACIONES



COLORES PERSONALIZADOS



FABRICADO E IMPRESO EN FABRICAS BIC



FABRICADO EN EUROPA



CUMPLIMIENTO DE LA NORMATIVA



ISO certified



IMPRIM'VERT®

## ORIGIN

BIO BASED



ACEITE DE RICINO DE ORIGEN BIOLÓGICO



SERRÍN DE MADERA



TALCO



100% RECICLABLE



100% ELECTRICIDAD DE FUENTES RENOVABLES



BAJO IMPACTO AMBIENTAL

## TÉCNICAS DE IMPRESIÓN



SERIGRAFÍA

**BIC® WIDE BODY™**

**¡El tamaño correcto  
para enseñar el valor  
real de tu marca!**

**De perfil ancho y gran  
variedad de posibilidades  
para maximizar tu mensaje.**







¡Icónico BIC® Boy en relieve!

## BIC® WIDE BODY™

1079 Opaco Chrome

1080 Opaco

Color de tinta



Tinta roja bajo consulta



¡Versión ECO y standard al mismo precio!

## ecolutions®



FABRICADO DE 94% DE MATERIAL RECICLADO\*\*



BANDEJAS DE FRUTAS Y VERDURAS

## BIC® WIDE BODY™

ecolutions® 1E80 Opaco

Color de tinta



Tinta roja bajo consulta



Disponible en cuerpo blanco



Disponible en cuerpo blanco



### ESPECIFICACIONES



COLORES PERSONALIZADOS



FABRICADO E IMPRESO EN FÁBRICAS BIC



FABRICADO EN ESPAÑA



CUMPLIMIENTO DE LA NORMATIVA



IMPRIM'VERT®

ecolutions®



BANDEJAS DE FRUTAS Y VERDURAS



RECICLABLE



100% ELECTRICIDAD DE FUENTES RENOVABLES



BAJO IMPACTO AMBIENTAL

### MODOS DE ESCRITURA



BOLÍGRAFO M

### TÉCNICAS DE IMPRESIÓN



SERIGRAFÍA



DIGITAL

\*48h no disponible en acabados digitales

\*\*Porcentaje calculado a partir del peso total del producto excluyendo el cartucho.

Debido al contenido reciclado de las primeras materias con las que se fabrica el producto, no podemos garantizar que los colores que aparecen en el catálogo, ni los colores customizados a la carta, tengan siempre el mismo color y apariencia.

**BIC® WIDE BODY™**

1080 Frosted

Color de tinta



40

63

67

68

69

66

71

100%

*Nuestra  
área de  
impresión  
más grande*

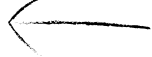

**BIC® WIDE BODY™**

**MINI DIGITAL**

1893 Opaco

1896 Chrome Opaco

Color de tinta



01

01

100%

*impresión  
360°*

*Disponible en  
cuerpo blanco*



### BIC® WIDE BODY™

1080 Opaco  
 ecolutions® 1E80 Opaco  
 1080 Frosted

### BIC® WIDE BODY™ MINI DIGITAL

1893 Opaco  
 1896 Chrome Opaco

Cantidad mínima 250 unidades  
 Combinación de colores estándar



Sin cargo extra

#### Botón



Opaco



Frosted

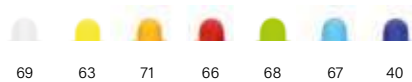

Chrome



#### Clip



Opaco

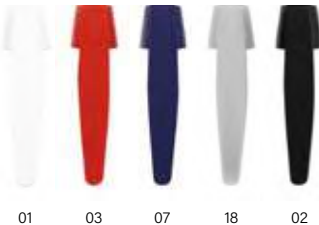

Frosted

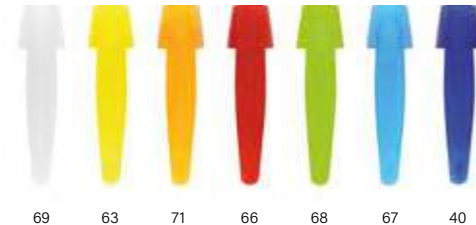

#### Cuerpo



Opaco



Frosted

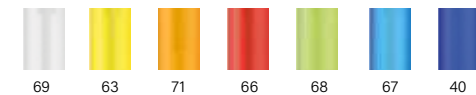

#### ESPECIFICACIONES



FABRICADO EN ESPAÑA



#### MODOS DE ESCRITURA



#### TÉCNICAS DE IMPRESIÓN



Opaco



ecolutions® \*\*\*



Añade el Möbius loop a tu arte final sin cargo adicional. Por favor asegúrate de especificarlo en tu pedido. (La impresión del Möbius loop a mano izquierda en la esquina)



BANDEJAS DE FRUTAS Y VERDURAS

#### Sección



Opaco



Frosted



Chrome



Color exacto: ≥ 10.000 unidades



\*Hasta que se acabe el stock

\*\*48h no disponible en acabados digitales

\*\*\* Debido al contenido reciclado de las primeras materias con las que se fabrica el producto, no podemos garantizar que los colores que aparecen en el catálogo, ni los colores customizados a la carta, tengan siempre el mismo color y apariencia.

# BIC® WIDE BODY™

## BIC® WIDE BODY™

1080 Opaco

1079 Opaco Chrome

eColutions® 1E80

A/C SP: máx. 2 col.

B/F SP: máx. 1 col.

D DG: a todo color (área para imágenes)

E DG: a todo color (área para texto)

Cantidad mínima 250 unidades. (SP)

Cantidad mínima 500 unidades. (DG)

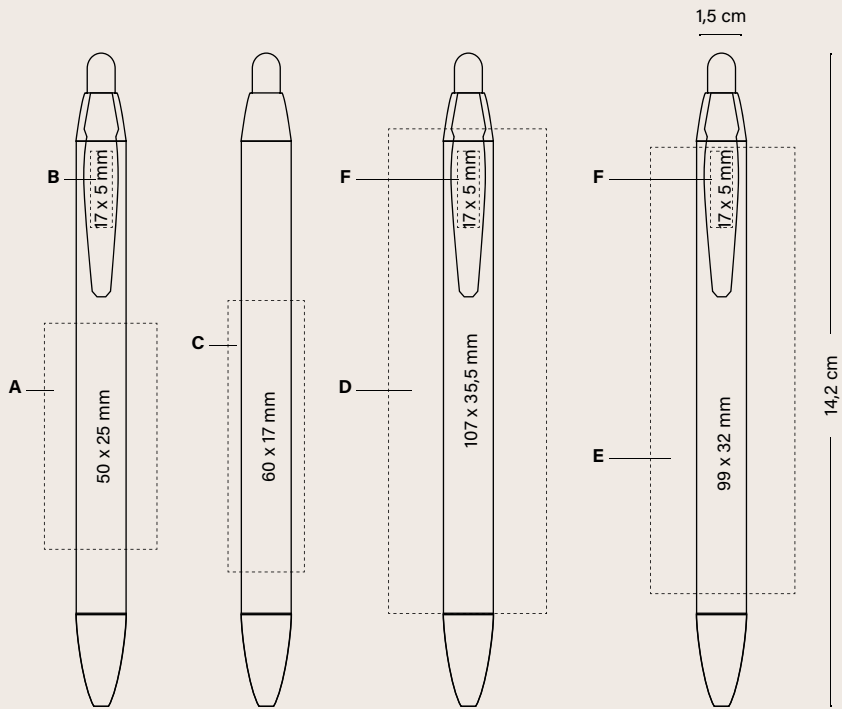

### EMBALAJE ESPECIAL OPCIONAL



+ INFO PÁGS. 222 A 227

### EMBALAJE EXTERIOR



*¡Nueva!  
Collection Box  
(1, 2 y 3 unidades)*

250 ± 2,6KG

**BIC® WIDE BODY™  
MINI DIGITAL**

1893

**BIC® WIDE BODY™  
MINI CHROME DIGITAL**

1896

**A DG:** a todo color (área para imágenes)

**B DG:** a todo color (área para texto)

Cantidad mínima 500 unidades. (DG)

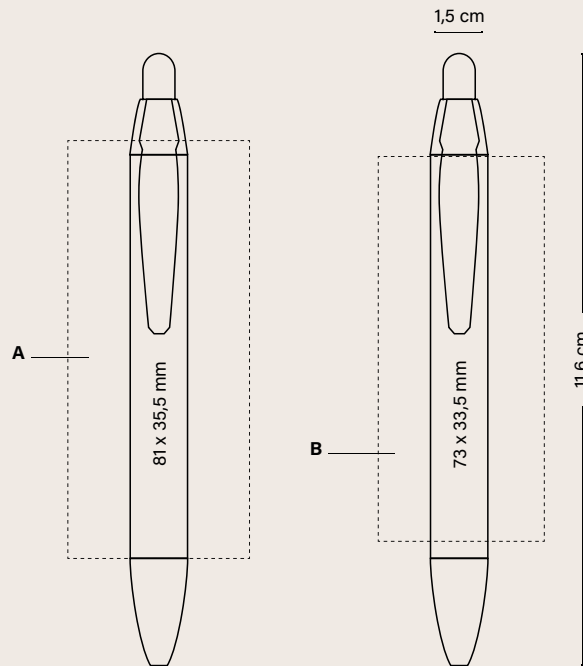

**EMBALAJE ESPECIAL OPCIONAL**



ECO SLEEVE



PLASTIC POUCH



WINDOW BOX



COLLECTION BOX

*¡Nueva!  
Collection Box  
(1, 2 y 3 unidades)*



250 ± 2,6KG

+ INFO PÁGS. 222 A 227

**EMBALAJE EXTERIOR**

**ESPECIFICACIONES**



**MODOS DE ESCRITURA**



**TÉCNICAS DE IMPRESIÓN**



Consulta la página 233 para una explicación detallada de los iconos

# BIC® WIDE BODY™ BGUARD™ ANTIBACTERIAL

BGUARD™



Protección contra las bacterias



Protección de la superficie del bolígrafo



Protección permanente



Test protocolo Anti-bacterias

**ANTIBACTERIAL™**

*¡Logo Antibacterial siempre visible!*

## WIDE BODY™ BGUARD™ ANTIBACTERIAL

1081 Opaco

Color de tinta



Tinta roja bajo consulta



1BG



2BG



3BG



7BG

100%



1BG

100%

*Impresión 360°*

*Disponible en cuerpo blanco*





Cantidad mínima 250 unidades

**Botón**

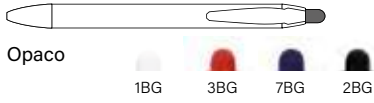

Opaco

**Cuerpo**



Opaco

**Clip**

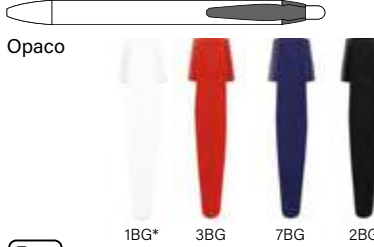

Opaco

**Sección**

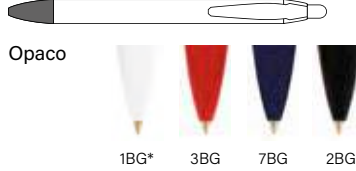

Opaco

Color exacto:  $\geq 10.000$  unidades

**BIC® WIDE BODY™  
BGUARD™  
ANTIBACTERIAL**  
1081

A/C SP: máx. 1 col.  
B/F SP: máx. 1 col.  
D DG: a todo color  
(área para imágenes)  
E DG: a todo color  
(área para texto)

Cantidad mínima  
250 unidades. (SP)

Cantidad mínima  
500 unidades. (DG)

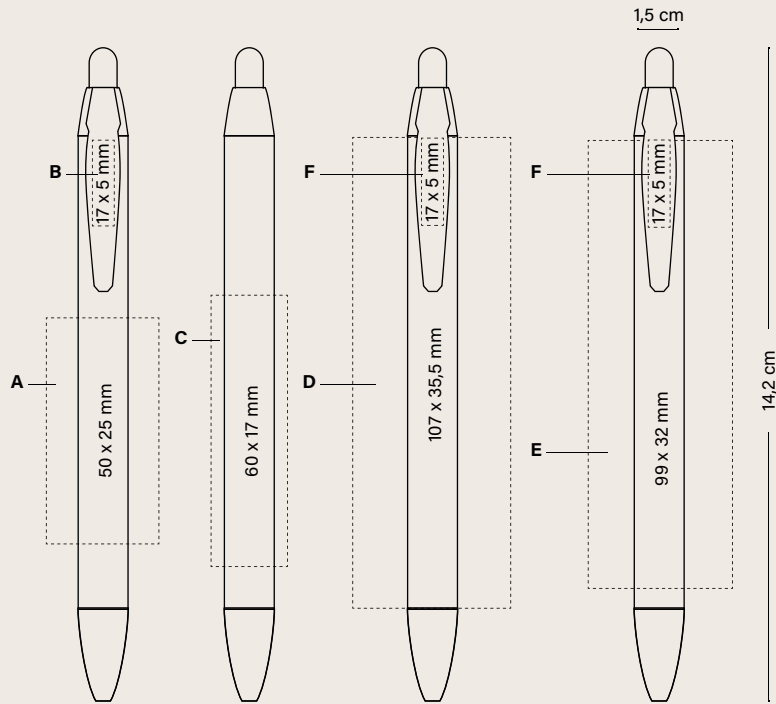

**EMBALAJE ESPECIAL OPCIONAL**



+ INFO PÁGS. 222 A 227

**EMBALAJE EXTERIOR**



**ESPECIFICACIONES**

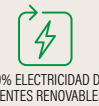

**MODOS DE ESCRITURA**



**TÉCNICAS DE IMPRESIÓN**







## BIC® 4 COLOURS®

---

El mundialmente reconocido bolígrafo BIC® 4 Colours® te ofrece la comodidad de cuatro colores de tinta diferentes en el mismo bolígrafo, lo que lo convierte en una excelente opción para organizar notas o apuntar datos en diferentes colores. Este bolígrafo tan versátil tiene una punta media de 1.0 mm y lleva tinta de larga duración. Para una mayor comodidad, puedes colgarle un lanyard o cordón, y llevarlo a cualquier parte. Descubre todas las versiones: Classic, Sun, Fashion, Fine, Shine, Fluo, 3+1<sup>HB</sup> (con portaminas), Glacé y las últimas versiones Soft y Wood Style. ¿A qué esperas para empezar tu colección?

**Soft**

**Wood Style**

**Sun**

**Fashion**

**Shine**

**Glacé**

**Fine**

**Fluo**

**3+1<sup>HB</sup>**



¡LA SOLUCIÓN PARA UNA  
COMUNICACIÓN A  
TODO COLOR!

*Ahora en cuerpos  
de colores*

**BIC® 4 COLOURS®**

1100 Opaco

1101 Con cordón

Color de tinta





Personalización

**BIC® 4 COLOURS®**

1100/1101

**A SP:** máx. 4 col.

**B DG:** Digital print (área para imágenes)

**C BP:** a todo color

Cantidad mínima 250 unidades (SP, DG)

Cantidad mínima 100 unidades (BP)

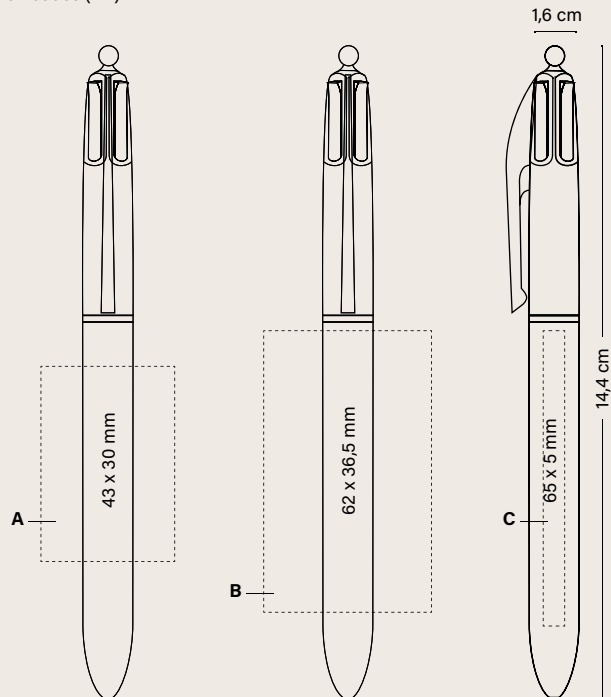

EMBALAJE ESPECIAL OPCIONAL

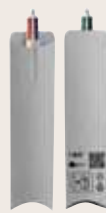

ECO SLEEVE



PLASTIC POUCH



WINDOW BOX



COLLECTION BOX



250 ± 3,2KG

¡Nueva!  
Collection Box  
(1, 2 y 3 unidades)

+ INFO PÁGS. 222 A 227

EMBALAJE EXTERIOR

ESPECIFICACIONES



COLORES PERSONALIZADOS



FABRICADO E IMPRESO EN FÁBRICAS BIC



FABRICADO EN FRANCIA



CUMPLIMIENTO DE LA NORMATIVA



ISO certified



IMPRIM'VERT®



100% RECICLABLE



100% ELECTRICIDAD DE FUENTES RENOVABLES



BAJO IMPACTO AMBIENTAL

MODOS DE ESCRITURA



BOLÍGRAFO M

TÉCNICAS DE IMPRESIÓN



SP  
SERIGRAFÍA



DG  
DIGITAL



BP  
BRITEPIX™

Consulta la página 233 para una explicación detallada de los iconos

BIC® 4 COLOURS® SOFT

¡Un tacto suave que no  
querrás dejar de tocar!



**BIC® 4 COLOURS® SOFT**

1060 Opaco

1063 Con cordón

Color de tinta



01/03F



01/02F



**collection**



*Siente  
la suavidad  
en tus manos*



*Servicio de  
recarga bajo  
petición*



01/07F



# BIC® 4 COLOURS® SOFT

## Personalización

### BIC® 4 COLOURS® SOFT

1060/1063

A SP: máx. 1 col.

Cantidad mínima 250 unidades

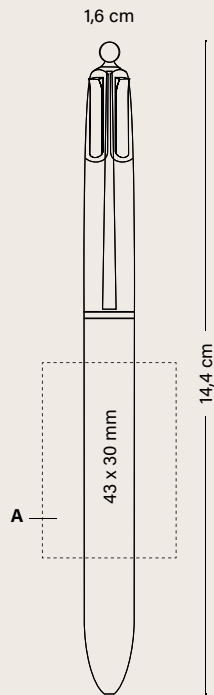

## EMBALAJE ESPECIAL OPCIONAL



ECO SLEEVE



PLASTIC POUCH



WINDOW BOX



COLLECTION BOX

*¡Nueva!  
Collection Box  
(1, 2 y 3 unidades)*

+ INFO PÁGS. 222 A 227

## EMBALAJE EXTERIOR



250 ± 3,2KG

## ESPECIFICACIONES



COLORES PERSONALIZADOS



FABRICADO E IMPRESO EN FABRICAS BIC



FABRICADO EN FRANCIA



CUMPLIMIENTO DE LA NORMATIVA



IMPRIM'VERT®



100% RECICLABLE



100% ELECTRICIDAD DE FUENTES RENOVABLES



BAJO IMPACTO AMBIENTAL

## MODOS DE ESCRITURA



BOLÍGRAFO M

## TÉCNICAS DE IMPRESIÓN



SERIGRAFÍA

BIC® 4 COLOURS® WOOD STYLE

# ¡Déjate impresionar por el espectacular acabado efecto madera!



**BIC® 4 COLOURS® WOOD STYLE**

1061 Opaco  
1064 Con cordón

Color de tinta



01/6AW



01/05W



01/02W



01/12W

**collection**



*Aporta calidez a tu marca*



*Servicio de recarga bajo petición*



# BIC® 4 COLOURS® WOOD STYLE

## Personalización

### BIC® 4 COLOURS® WOOD STYLE

1061/1064

A SP: máx. 2 col.

Cantidad mínima 250 unidades

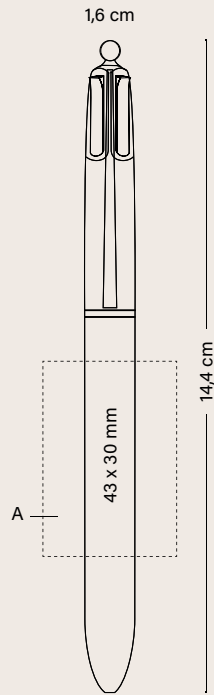

## EMBALAJE ESPECIAL OPCIONAL

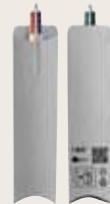

ECO SLEEVE



PLASTIC POUCH



WINDOW BOX



COLLECTION BOX

*¡Nueva!  
Collection Box  
(1, 2 y 3 unidades)*



250 ± 3,2KG

+ INFO PÁGS. 222 A 227

## ESPECIFICACIONES



COLORES PERSONALIZADOS



FABRICADO E IMPRESO EN FABRICAS BIC



FABRICADO EN FRANCIA



CUMPLIMIENTO DE LA NORMATIVA



ISO certified



IMPRIM'VERT®



100% RECICLABLE



100% ELECTRICIDAD DE FUENTES RENOVABLES



BAJO IMPACTO AMBIENTAL

## MODOS DE ESCRITURA



BOLÍGRAFO M

## TÉCNICAS DE IMPRESIÓN



SERIGRAFÍA



¡LA SOLUCIÓN PARA UNA  
COMUNICACIÓN A  
TODO COLOR!

**BIC® 4 COLOURS® SUN**

- 1097 Opaco
- 1098 Con cordón
- Color de tinta



01/12



01/12

*Colores llamativos:  
naranja y amarillo*

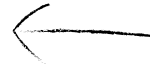

*Servicio de  
recarga bajo  
petición*



100%

Personalización

**BIC® 4 COLOURS® SUN**

1097/1098

**A SP:** máx. 4 col.

**B DG:** Digital print (área para imágenes)

**C BP:** a todo color

Cantidad mínima 250 unidades (SP, DG)

Cantidad mínima 100 unidades (BP)

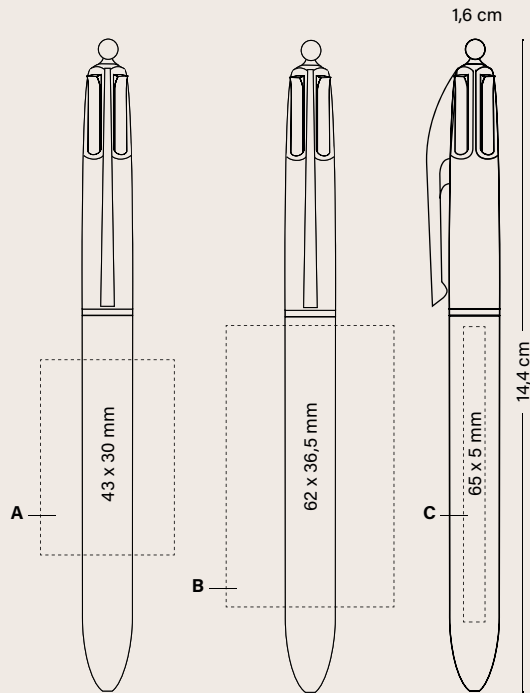

EMBALAJE ESPECIAL OPCIONAL



ECO SLEEVE



PLASTIC POUCH



WINDOW BOX



COLLECTION BOX



250 ± 3,2KG

*¡Nueva!  
Collection Box  
(1, 2 y 3 unidades)*

+ INFO PÁGS. 222 A 227

EMBALAJE EXTERIOR

ESPECIFICACIONES



MODOS DE ESCRITURA



TÉCNICAS DE IMPRESIÓN



Consulta la página 233 para una explicación detallada de los iconos



¡LA SOLUCIÓN PARA UNA COMUNICACIÓN A TODO COLOR!

*Ahora en cuerpos de colores*

**4 COLOURS® FASHION**

1102 Opaco

1108 Con cordón

Color de tinta





Personalización

**BIC® 4 COLOURS® FASHION**  
1102/1108

- A SP:** máx. 4 col.
- B DG:** Digital print (área para imágenes)
- C BP:** a todo color

Cantidad mínima 250 unidades (SP, DG)  
Cantidad mínima 100 unidades (BP)

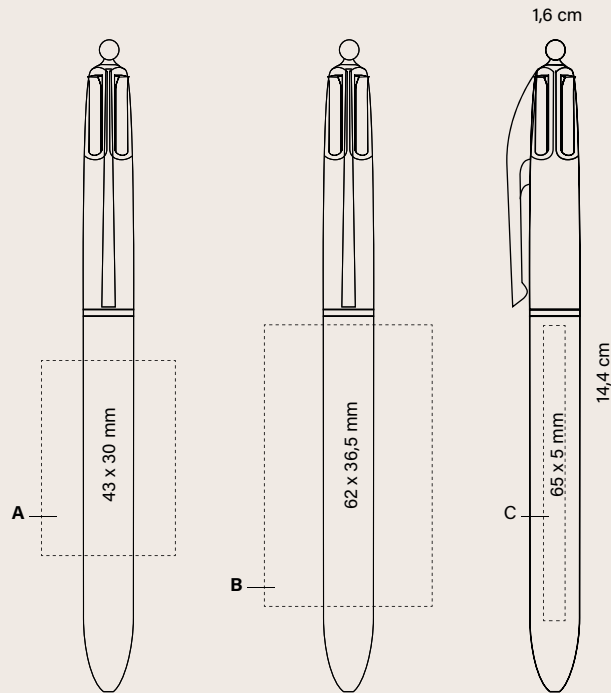

EMBALAJE ESPECIAL OPCIONAL



+ INFO PÁGS. 222 A 227

EMBALAJE EXTERIOR



¡Nueva!  
Collection Box  
(1, 2 y 3 unidades)

ESPECIFICACIONES



MODOS DE ESCRITURA



TÉCNICAS DE IMPRESIÓN



BRITEPIX™  
BRITEPIX™ TEXTURE  
BRITEPIX™ PERSONALISATION

Consulta la página 233 para una explicación detallada de los iconos

BIC® 4 COLOURS® SHINE

# Haz que tu marca brille

**BIC® 4 COLOURS® SHINE**

1106 Opaco

1107 Con cordón

Color de tinta



01/75



01/26



01/7G

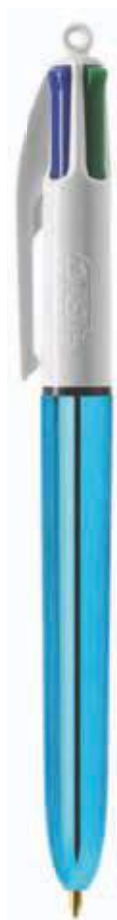

01/34



*¡Cuerpos super  
brillantes!*



*Servicio de  
recarga bajo  
petición*



01/97

**collection**



## Personalización

**BIC® 4 COLOURS® SHINE**  
1106/1107

**A SP:** máx. 2 col.

**B LE**

**C LE**

**D LE:** 360°

Cantidad mínima 250 unidades

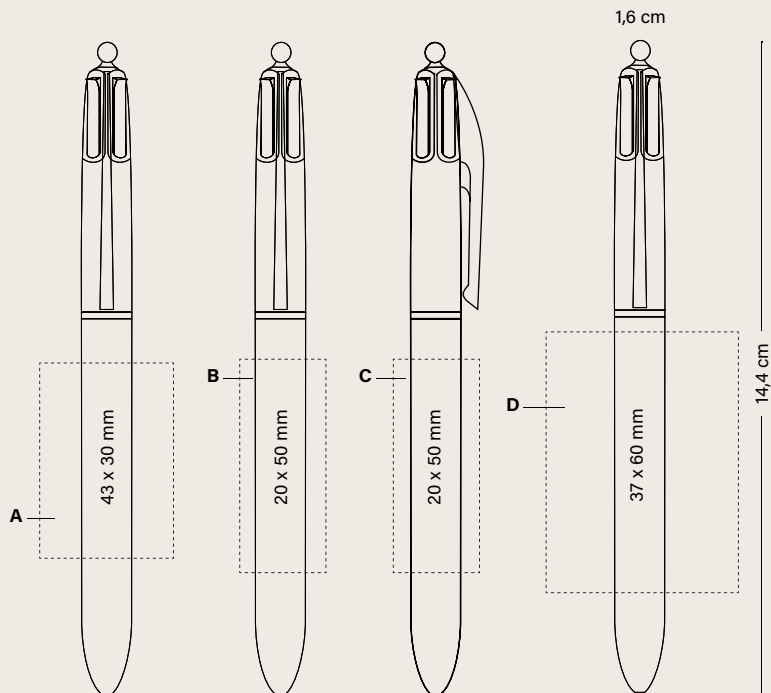

### EMBALAJE ESPECIAL OPCIONAL



ECO SLEEVE



PLASTIC POUCH



WINDOW BOX



COLLECTION BOX

*¡Nueva!  
Collection Box  
(1, 2 y 3 unidades)*



250 ± 3,2KG

+ INFO PÁGS. 222 A 227

### EMBALAJE EXTERIOR

## ESPECIFICACIONES



FABRICADO E IMPRESO EN FABRICAS BIC



FABRIQUÉ EN FRANCE  
FABRICADO EN FRANCIA



CUMPLIMIENTO DE LA NORMATIVA



ISO certified



IMPRIM'VERT®  
100%  
RECICLABLE



100% ELECTRICIDAD DE FUENTES RENOVABLES



BAJO IMPACTO AMBIENTAL

## MODOS DE ESCRITURA



BOLIÓGRAFO M

## TÉCNICAS DE IMPRESIÓN



SP  
SERIGRAFÍA



LE  
LASER

BIC® 4 COLOURS® GLACÉ

# Nuestro clásico bolígrafo se viste de gala

---

**BIC® 4 COLOURS® GLACÉ**

1057 Opaco

1058 Con cordón

Color de tinta



**collection**



# BIC® 4 COLOURS® GLACÉ

## Personalización

**BIC® 4 COLOURS® GLACÉ**  
1057/1058

**A SP:** máx. 2 col.

Cantidad mínima 250 unidades

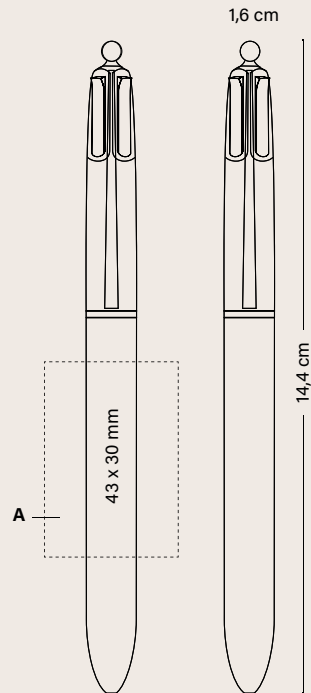

## EMBALAJE ESPECIAL OPCIONAL



ECO SLEEVE



PLASTIC POUCH



WINDOW BOX



COLLECTION BOX

*¡Nueva!  
Collection Box  
(1, 2 y 3 unidades)*



250 ± 3,2KG

+ INFO PÁGS. 222 A 227

## EMBALAJE EXTERIOR

## ESPECIFICACIONES



COLORES PERSONALIZADOS



FABRICADO E IMPRESO EN FABRICAS BIC



FABRICADO EN FRANCIA



CUMPLIMIENTO DE LA NORMATIVA



IMPRIM'VERT®



RECICLABLE



100% ELECTRICIDAD DE FUENTES RENOVABLES



BAJO IMPACTO AMBIENTAL

## MODOS DE ESCRITURA



BOLÍGRAFO M

## TÉCNICAS DE IMPRESIÓN



SERIGRAFÍA



¡LA SOLUCIÓN PARA UNA COMUNICACIÓN A TODO COLOR!

**BIC® 4 COLOURS® FINE**

1109 Opaco  
1111 Con cordón

Color de tinta



01/10

01/10

↑  
punta de 0.8mm

Personalización

**BIC® 4 COLOURS® FINE**

1109/1111

**A SP:** máx. 4 col.

**B DG:** Digital print

**C BP:** a todo color

Cantidad mínima 250 unidades (SP, DG)

Cantidad mínima 100 unidades (BP)

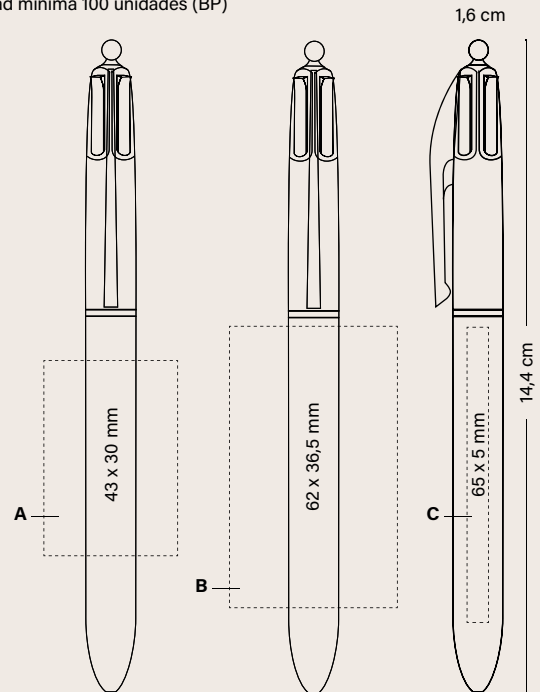

ENVASE ESPECIAL OPCIONAL



+ INFO PÁGS. 222 A 227

EMBALAJE EXTERIOR



ESPECIFICACIONES



COLORES PERSONALIZADOS



FABRICADO E IMPRESO EN FÁBRICAS BIC



FABRICADO EN FRANCIA



CUMPLIMIENTO DE LA NORMATIVA



RECICLABLE



100% ELECTRICIDAD DE FUENTES RENOVABLES



BAJO IMPACTO AMBIENTAL

MODOS DE ESCRITURA



BOLÍGRAFO F

TÉCNICAS DE IMPRESIONES



SERIGRAFÍA



BRITEPIX™

Consulta la página 233 para una explicación detallada de los iconos.  
\*48h no disponible en acabados digitales. Disponible sin cordón





**BIC® 4 COLOURS® FLUO**  
 1114 Opaco  
 1116 Con cordón  
 Color de tinta  
● ● ● ●

Personalización

**BIC® 4 COLOURS® FLUO**

1114/1116

**A SP:** máx. 4 col.

**B BP:** a todo color

Cantidad mínima 250 unidades (SP, DG)

Cantidad mínima 100 unidades (BP)

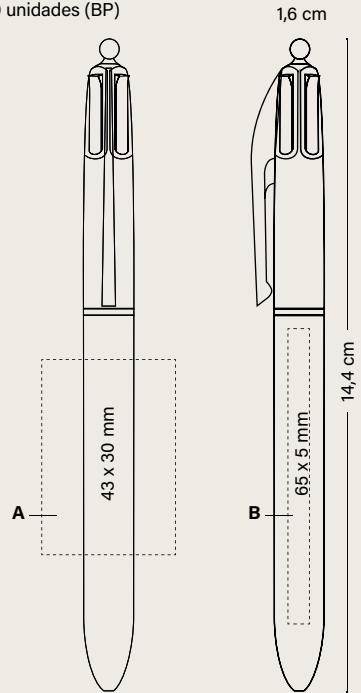

ENVASE ESPECIAL OPCIONAL



+ INFO PÁGS. 222 A 227

*¡Nueva!  
 Collection Box  
 (1, 2 y 3  
 unidades)*

EMBALAJE EXTERIOR



ESPECIFICACIONES



MODOS DE ESCRITURA



TÉCNICAS DE IMPRESIONES



Consulta la página 233 para una explicación detallada de los iconos.  
 \*48h no disponible en acabados digitales. Disponible sin cordón

**BIC® 4 COLOURS® 3+1<sup>HB</sup>**  
1099 Opaco  
Color de tinta  
●●●●



Personalización

**BIC® 4 COLOURS® 3+1<sup>HB</sup>**

1099 Opaco

**A/B LE**

Cantidad mínima 250 unidades  
Combinación de colores estándar

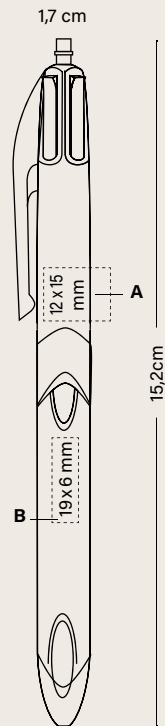

ESPECIFICACIONES



COLORES PERSONALIZADOS



FABRICADO E IMPRESO EN FABRICAS BIC



CUMPLIMIENTO DE LA NORMATIVA



ISO certified



IMPRIM'VERT®



100% RECICLABLE



100% ELECTRICIDAD DE FUENTES RENOVABLES



BAJO IMPACTO AMBIENTAL

MODOS DE ESCRITURA



BOLÍGRAFO M



PORTAMINAS MP Ø 0,7MM

TÉCNICAS DE IMPRESIÓN



LASER

ENVASE ESPECIAL OPCIONAL



PLASTIC POUCH



COLLECTION BOX

*¡Nueva!  
Collection Box  
(1, 2 y 3 unidades)*

+ INFO PÁGS. 222 A 227

EMBALAJE EXTERIOR



250 ± 3,5 KG



MIRA EL VÍDEO

Consulta la página 233 para una explicación detallada de los iconos

BIC® METAL PRO

# Detalles metálicos, diseño moderno con una gran selección de colores y acabados.

**BIC® METAL PRO**  
1290 Soft  
Color de tinta  
● ●



01F



10F\*



03F\*



02F



04F

*Máximo confort de escritura*

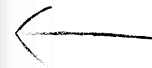

*Tinta alemana, te permite escribir hasta 8 km*

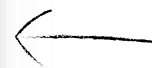

## BIC® METAL PRO

1290 Pulido

Color de tinta



01E



02E



03E\*



05E\*



04E



06P\*

### ESPECIFICACIONES



MONTAJE E IMPRESIÓN EN FÁBRICAS BIC



FABRICADO EN ALEMANIA



CUMPLIMIENTO DE LA NORMATIVA



ISO certified



IMPRIM'VERT®



RECICLABLE

### MODOS DE ESCRITURA



BOLÍGRAFO M

### TÉCNICAS DE IMPRESIÓN



SERIGRAFÍA



LASER

---

## BIC® METAL PRO

1290 Mate

Color de tinta



01D



10D\*



03D\*



02D



04D

100%



Personalización

**BIC® METAL PRO**

1290

**A SP:** máx. 2 col.  
(no disponible en acabado soft)

**B LE/SP:** máx. 1 col.

**C LE 360°**

Cantidad mínima 50 unidades

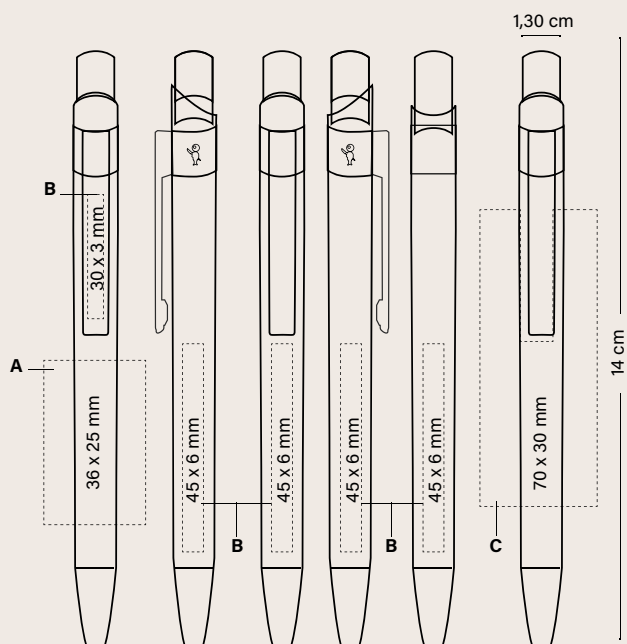

**ENVASE ESPECIAL OPCIONAL**

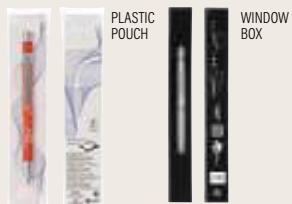

+ INFO PÁGS. 222 A 227

**EMBALAJE EXTERIOR**



**ESPECIFICACIONES**



MONTAJE E IMPRESIÓN EN FÁBRICAS BIC



FABRICADO EN ALEMANIA



CUMPLIMIENTO DE LA NORMATIVA



ISO certified



IMPRIM'VERT®



100% RECICLABLE

**MODOS DE ESCRITURA**



BOLÍGRAFO M

**TÉCNICAS DE IMPRESIÓN**



SP SERIGRAFIA



LE LÁSER





# BIC® CRISTAL® RE'NEW™

---

El icónico BIC® Cristal® en versión metal.  
El nuevo BIC® Cristal® Re'New™ añade al icónico BIC® Cristal® Original un toque de modernidad con su cuerpo de aluminio mate y el logotipo BIC® grabado con láser.

El capuchón también ha sido rediseñado: es gris mate y está fabricado con un 96% de plástico reciclado. Recargable, con tintas azul o negra. Incluye 2 cartuchos.

La misma ingeniosa forma hexagonal que el original BIC® Cristal® para un buen agarre y comodidad. Diseño sostenible, de calidad y valor atemporal. El producto viene en la cajita BIC® Window Box.

BIC® CRISTAL®  
RE'NEW™

1090

Color de tinta



BIC® WINDOW BOX

*¡Tu Cristal® Re'New™  
siempre con este envase!*

(Incluido en el precio)

Personalización

**BIC® CRISTAL® RE'NEW™**  
1090

A LE: máx. 1 col.

Cantidad mínima 25 unidades

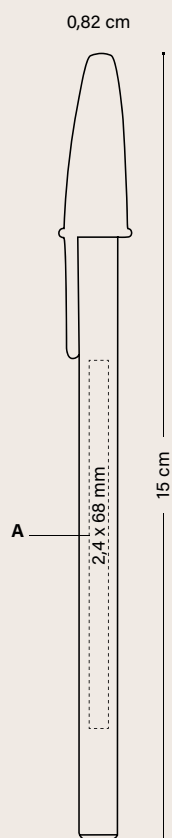

EMBALAJE EXTERIOR



44 ± 1KG

ESPECIFICACIONES



FABRICADO E IMPRESO EN FÁBRICAS BIC



CUMPLIMIENTO DE LA NORMATIVA



ISO certified



IMPRIM'VERT®



100%  
RECICLABLE

MODOS DE ESCRITURA



BOLÍGRAFO M

TÉCNICAS DE IMPRESIÓN



LÁSER







## BIC® GRIP ROLLER

---

Disfruta de una experiencia de escritura suave, fluida y de larga duración. Se desliza fácilmente a través del papel y sin manchas gracias a la tinta de secado rápido, ideal tanto para las personas zurdas como diestras.



# BIC® GRIP ROLLER



ESCRITURA MEDIA  
Ø 0,7 MM

*Tinta de alta calidad con la punta roller  
mediaana para una escritura suave y fluida*

## BIC® GRIP ROLLER

1187

Color de tinta



01/35

También disponible  
en tinta azul



12/35



10/35



03/35



59/35



24/35



07/35

También disponible  
en tinta azul



06/35



27/35



02/35

También disponible  
en tinta azul



14/35

100%

Personalización

**BIC® GRIP ROLLER**  
1187

A/B SP: máx. 3 col.

Cantidad mínima 250 unidades

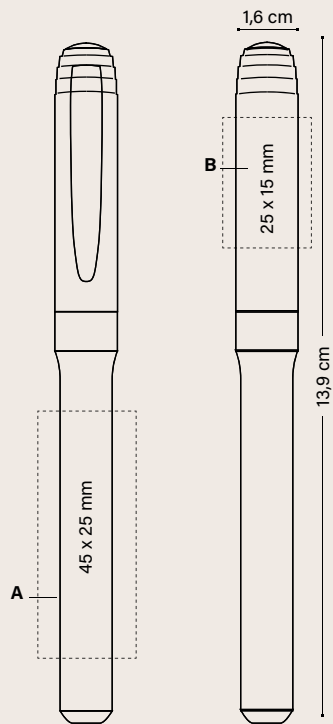

ESPECIFICACIONES



FABRICADO E IMPRESO EN FÁBRICAS BIC



CUMPLIMIENTO DE LA NORMATIVA



ISO certified



IMPRIM'VERT®

100%  
RECICLABLE

MODOS DE ESCRITURA



ROLLER R  
Ø 0,7 MM

TÉCNICAS DE IMPRESIÓN



SP  
SERIGRAFIA

ENVASE ESPECIAL OPCIONAL



ECO SLEEVE

PLASTIC POUCH

WINDOW BOX

MARKING SET

COLLECTION BOX

+ INFO PÁGS. 222 A 227

EMBALAJE EXTERIOR



250 ± 3 KG

¡Nueva! Collection Box  
(1, 2 y 3 unidades)

## BIC® XS FINESTYLE

1851 Opaco  
Color de tinta



01/03



01/25



01/06

## BIC® XS FINESTYLE

1851 Transparente  
Color de tinta



100%

89/01

Personalización

**BIC® XS FINESTYLE**

1851

**A PD:** máx. 2 col.

**B SP:** máx. 2 col.

**C BP:** a todo color

Cantidad mínima 250 unidades

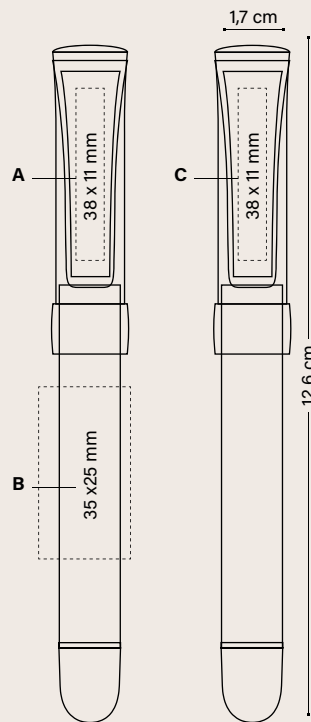

Color exacto:

**ENVASE ESPECIAL OPCIONAL**



ECO SLEEVE



PLASTIC POUCH

+ INFO PÁGS. 222 A 227

**EMBALAJE EXTERIOR**



250 ± 2,8KG

**ESPECIFICACIONES**



**MODOS DE ESCRITURA**



ESCRITURA FINESTYLE  
Ø 0,7 MM

**TÉCNICAS DE IMPRESIÓN**



SERIGRAFÍA



TAMOGRAFÍA



BRITEPIX™  
BRITEPIX™  
TEXTURE  
BRITEPIX™  
PERSONALISATION

Consulta la página 233 para una explicación detallada de los iconos



*Iconico BIC®  
Boy en relieve*

---

**BIC® INTENSITY®  
GEL CLIC**

1196 Opaco  
Color de tinta



01



02

100%

---

**BIC® INTENSITY®  
GEL CLIC**

1196 Transparente  
Color de tinta



92



88



86

100%

Personalización

**BIC® INTENSITY® GEL CLIC**

1196

**A SP:** máx. 2 col.

**B SP:** máx. 4 col.

Cantidad mínima 250 unidades

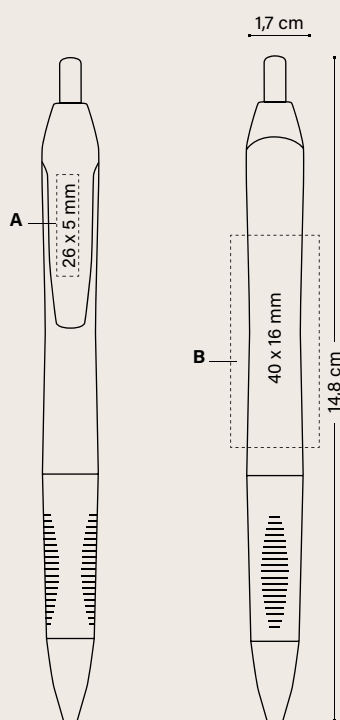

ESPECIFICACIONES



FABRICADO E IMPRESO EN FÁBRICAS BIC



CUMPLIMIENTO DE LA NORMATIVA



IMPRIM'VERT®



RECICLABLE

MODOS DE ESCRITURA



GEL G  
Ø 0,7 MM

TÉCNICAS DE IMPRESIÓN



SERIGRAFIA

ENVASE ESPECIAL OPCIONAL



PLASTIC  
POUCH

+ INFO PÁGS. 222 A 227

EMBALAJE EXTERIOR



250 ± 3,7KG

Consulta la página 233 para una explicación detallada de los iconos





Plan B

A A A A A

→ Sol  
Oibuo





# RESALTADORES Y MARCADORES BIC®

---

Los resaltadores y marcadores BIC® están diseñados para escribir visiblemente en un amplio rango de superficies. Exprésate con claridad sin importar la superficie.

**BIC® Brite Liner® Grip**

**BIC® Velleda® White Board Marker Fine**

**BIC® Velleda® White Board Marker Grip**

**BIC® Mark-It Permanent Marker**

**BIC® Permanent Marker Ecolutions®**

# BIC® BRITE LINER® GRIP

BIC® BRITE LINER® GRIP  
1192



Personalización

**BIC® BRITE LINER® GRIP**

1192

A/B SP: máx. 3 col.

Cantidad mínima 250 unidades

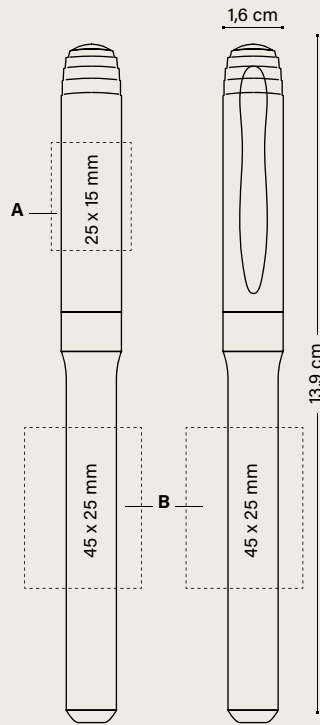

ENVASE ESPECIAL OPCIONAL



+ INFO PÁGS. 222 A 227



MARKING SET



COLLECTION BOX

*¡Nueva!  
Collection Box  
(1, 2 y 3  
unidades)*

EMBALAJE EXTERIOR



250 ± 2,8KG

ESPECIFICACIONES



FABRICADO E IMPRESO EN FABRICAS BIC



CUMPLIMIENTO DE LA NORMATIVA



ISO certified



100% RECICLABLE



NO SE SECA EN 24H

MODOS DE ESCRITURA



RESALTADOR HL

TÉCNICAS DE IMPRESIÓN



SP SERIGRAFÍA

APTO PARA



FAX



FOTOCOPIADORAS



IMPRESORAS



PAPEL

Consulta la página 233 para una explicación detallada de los iconos

# BIC® VELLEDA® WHITE BOARD MARKER FINE

Velleda®

**BIC® VELLEDA® WHITE BOARD MARKER FINE**  
1651



01/04

Color de tinta



01/02

Color de tinta

100%

Personalización

**BIC® VELLEDA® WHITE BOARD MARKER FINE**  
1651

A SP: máx. 1 col.

Cantidad mínima 500 unidades

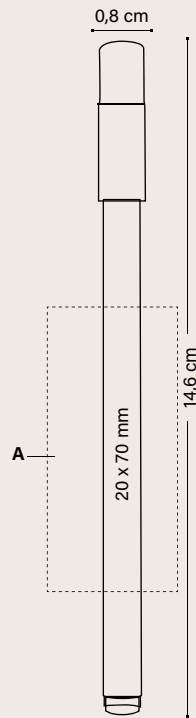

ENVASE ESPECIAL OPCIONAL



MARKING SET

*¡Ahora puedes tenerlo en set!*

+ INFO PÁGS. 222 A 227

EMBALAJE EXTERIOR



500 ± 3,2KG

ESPECIFICACIONES

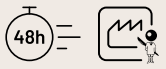

FABRICADO E IMPRESO EN FÁBRICAS BIC



FABRICADO EN FRANCIA



CUMPLIMIENTO DE LA NORMATIVA



RECICLABLE



BAJO IMPACTO AMBIENTAL



PUNTA RESISTENTE

MODOS DE ESCRITURA



MARCADOR MK

TÉCNICAS DE IMPRESIÓN



SERIGRAFÍA

# BIC® VELLEDA® WHITE BOARD MARKER GRIP

Velleda®

**BIC® VELLEDA® WHITE BOARD MARKER GRIP**  
1213



→  
*Grip de goma para mayor precisión y control*

01/02

●  
Color de tinta

100%

Personalización

**BIC® VELLEDA® WHITE BOARD MARKER GRIP**  
1213

A/B SP: máx. 3 col.

Cantidad mínima 250 unidades

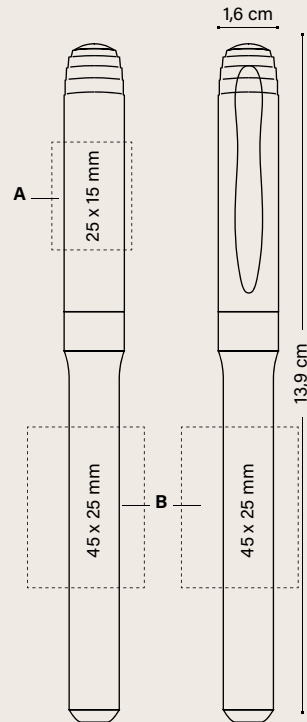

ENVASE ESPECIAL OPCIONAL



MARKING SET

EMBALAJE EXTERIOR



250 ± 2,7KG

*¡Ahora puedes tenerlo en set!*

+ INFO PÁGS. 222 A 227

ESPECIFICACIONES



FABRICADO E IMPRESO EN FABRICAS BIC



CUMPLIMIENTO DE LA NORMATIVA



ISO certified



IMPRIM'VERT®



RECICLABLE



PUNTA RESISTENTE

MODOS DE ESCRITURA



MARCADOR PIZARRA BLANCA MK

TÉCNICAS DE IMPRESIÓN



SERIGRAFÍA

# BIC® MARK-IT PERMANENT MARKER

**BIC® MARK-IT  
PERMANENT  
MARKER**  
1214



*Grip de  
goua para  
mayor  
precisión y  
control*

01/02  
●  
Color de tinta

01/04  
●  
Color de tinta

100%

## Personalización

**BIC® MARK-IT  
PERMANENT MARKER**  
1214

A/B SP: máx. 3 col.

Cantidad mínima 250 unidades

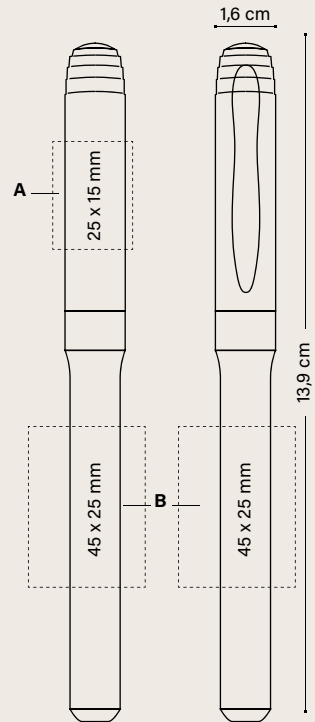

## ENVASE ESPECIAL OPCIONAL



MARKING  
SET



250 ± 2,8KG

*¡Ahora puedes  
tenerlo en set!*

+ INFO PÁGS. 222 A 227

## ESPECIFICACIONES



FABRICADO E IMPRESO  
EN FABRICAS BIC



CUMPLIMIENTO  
DE LA NORMATIVA



RECICLABLE



BAJO IMPACTO  
AMBIENTAL



PUNTA  
RESISTENTE

## MODOS DE ESCRITURA



MARCADOR  
MK

## TÉCNICAS DE IMPRESIÓN



SERIGRAFÍA

Consulta la página 233 para una explicación detallada de los iconos



# BIC® PERMANENT MARKER ECOLUTIONS®



**FABRICADO DE 51% DE MATERIAL RECICLADO\***

Añade el Möbius loop a tu arte final sin cargo adicional. Por favor asegúrate de especificarlo en tu pedido. (La impresión del Möbius loop a mano izquierda en la esquina).



ENVASES FARMACÉUTICOS

## BIC® PERMANENT MARKER ecolutions® 1210



02

Color de tinta



02

Color de tinta

100%

### Personalización

## BIC® PERMANENT MARKER ecolutions® 1210

A SP: máx. 1 col.

Cantidad mínima 250 unidades

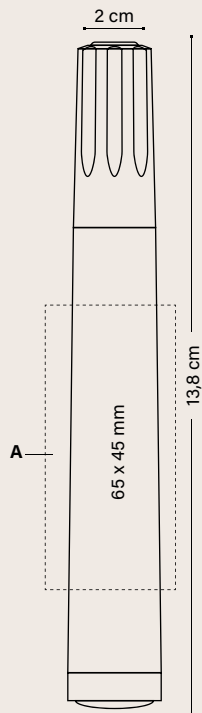

### EMBALAJE EXTERIOR



250 ± 2,6KG

#### ESPECIFICACIONES



FABRICADO E IMPRESO EN FÁBRICAS BIC



FABRICADO EN FRANCIA



CUMPLIMIENTO DE LA NORMATIVA



ENVASES FARMACÉUTICOS



RECICLABLE



BAJO IMPACTO AMBIENTAL



PUNTA RESISTENTE



MARCADOR MK

#### MODOS DE ESCRITURA

#### TÉCNICAS DE IMPRESIÓN



SERIGRAFÍA

\* Porcentaje calculado a partir del peso total del producto excluyendo el cartucho. Debido al contenido reciclado de las primeras materias con las que se fabrica el producto, no podemos garantizar que los colores que aparecen en el catálogo, ni los colores customizados a la carta, tengan siempre el mismo color y apariencia. Consulta la página 233 para una explicación detallada de los iconos





# PORTAMINAS BIC®

---

Siempre preparados con estos portaminas de calidad superior. Son sólidos, resistentes y no es necesario sacarle punta. ¡Escribe más fluido e intenso que nunca!

**BIC® Matic®**

**BIC® Media Clic Portaminas**

**54**

**BIC® Media Clic Grip Portaminas**

**58**

*¡Versión ECO  
y standard al mismo precio!*

**ecolutions®**



FABRICADO DE **65%  
DE MATERIAL RECICLADO\*\***

Añade el Möbius loop a tu arte final sin cargo adicional. Por favor asegúrate de especificarlo en tu pedido. (La impresión del Möbius loop a mano izquierda en la esquina).



ENVASES  
FARMACÉUTICOS

**BIC® MATIC®**  
1120 Opaco



01/05\*

02/02

12/12\*

03/03

07/07

01/01

100%

**BIC® MATIC®  
QUARTZ**  
1121 Opaco



51/07\*

100%

**BIC® MATIC®  
ecolutions® 1E40 Opaco**



06/8C\*

04/8C\*

100%

\*\*Porcentaje calculado a partir del peso total del producto. Debido al contenido reciclado de las primeras materias con las que se fabrica el producto, no podemos garantizar que los colores que aparecen en el catálogo, ni los colores customizados a la carta, tengan siempre el mismo color y apariencia.   
\*Hasta que se acabe el stock

Personalización

**BIC® MATIC®**  
1120  
eColutions® 1E40

**BIC® MATIC® QUARTZ**  
1121  
**A SP:** máx. 1 col.  
(no disponible para  
BIC® Matic® Quartz)  
**B/C SP:** máx. 2 col.

Cantidad mínima 500 unidades

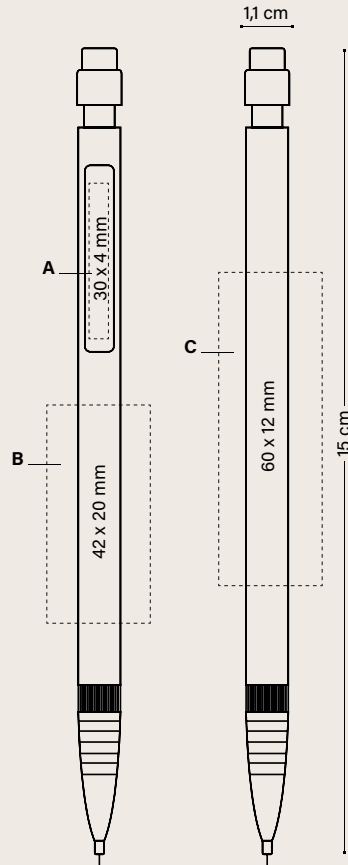

ENVASE ESPECIAL OPCIONAL



PLASTIC  
POUCH

+ INFO PÁGS. 222 A 227

EMBALAJE EXTERIOR



500 ± 3,1 KG

ESPECIFICACIONES



FABRICADO E  
IMPRESO EN  
FABRICAS BIC



FABRICADO EN FRANCIA



CUMPLIMIENTO  
DE LA NORMATIVA



IMPRIM'VERT®

eColutions®



ENVASES  
FARMACÉUTICOS



RECICLABLE



BAJO IMPACTO  
AMBIENTAL



ESCRITURA MÁS  
SUAVE Y OSCURA



FÁCIL DE USAR  
Y BORRAR



2 MINAS DE 9 CM

MODOS DE  
ESCRITURA



PORTAMINAS MP  
Ø 0,7 MM

TÉCNICAS DE  
IMPRESIÓN



SERIGRAFIA

Consulta la página 233 para una explicación detallada de los iconos







# LÁPICES BIC®

---

Lápiz de grafito de resina sintética, sin madera, hecho con hasta el 60% de material reciclado, que no se astilla en caso de rotura. Resistente mina de grafito HB.

**Evolution® Ecolutions®**





¡LA SOLUCIÓN PARA UNA COMUNICACIÓN A TODO COLOR!



¡LA SOLUCIÓN PARA UNA COMUNICACIÓN A TODO COLOR!



¡Icónica marca BIC® en relieve!

ecolutions®



FABRICADO DE 60% DE MATERIAL RECICLADO\*\*



NEVERAS Y ENVASES DE YOGURT

ecolutions®



FABRICADO DE 52,7% DE MATERIAL RECICLADO\*\*



NEVERAS Y ENVASES DE YOGURT

LÁPIZ SIN GOMA  
ecolutions® 1150

LÁPIZ CON GOMA  
ecolutions® 1151



\*\*Porcentaje calculado a partir del peso total del producto. Debido al contenido reciclado de las primeras materias con las que se fabrica el producto, no podemos garantizar que los colores que aparecen en el catálogo, ni los colores customizados a la carta, tengan siempre el mismo color y apariencia. \*\*\*48h no disponible en acabados digitales.

**ecolutions®**  
 FABRICADO DE 60%  
 DE MATERIAL RECICLADO\*\*



Añade el Möbius loop a tu arte final sin cargo adicional. Por favor asegúrate de especificarlo en tu pedido. (La impresión del Möbius loop a mano izquierda en la esquina).

**LÁPIZ DE GRAFITO  
 CON Y SIN GOMA**  
 1150/1151

Cantidad mínima 500 unidades  
 Combinación de colores estándar

**Goma**

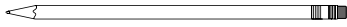

Opaco

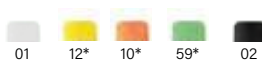

**Virola**

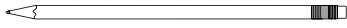

Opaco



**Cuerpo**



Opaco

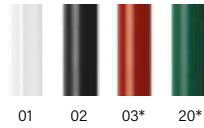

Sin cargo extra

**ESPECIFICACIONES**



FABRICADO E  
 IMPRESO EN  
 FABRICAS BIC

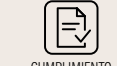

CUMPLIMIENTO  
 DE LA NORMATIVA



RECICLABLE



BAJO IMPACTO  
 AMBIENTAL



PUNTA RESISTENTE



NO SE  
 ASTILLA



PROTECTOR  
 DE MINA



FÁCIL DE USAR  
 Y BORRAR

**MODOS DE  
 ESCRITURA**



LÁPIZ PC HB  
 Ø 2,3MM

**TÉCNICAS DE  
 IMPRESIÓN**



SERIGRAFÍA



DIGITAL

Consulta la página 233 para una explicación detallada de los iconos

\*Hasta que se acabe el stock.



Personalización

**BIC® EVOLUTION® ECOLUTIONS®**  
**ECOLUTIONS® 1150** (Lápiz sin goma)

A SP: máx. 1 col.

Cantidad mínima 500 unidades

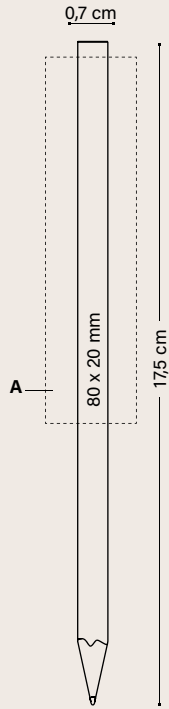

Personalización

**BIC® EVOLUTION® ECOLUTIONS®**  
**ECOLUTIONS® 1151** (Lápiz con goma)

Cantidad mínima 500 unidades

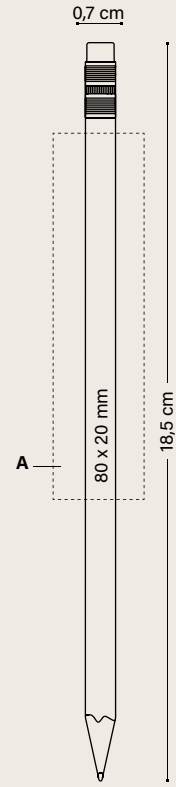

ENVASE ESPECIAL OPCIONAL



PLASTIC  
 POUCH  
 (x 3 UNIDADES)

*¡Ahora puedes  
 tenerlo en set!*

+ INFO PÁGS. 222 A 227

EMBALAJE EXTERIOR



500 ± 3,5 KG

Personalización

**BIC® EVOLUTION® ECOLUTIONS®**  
**ECOLUTIONS® 1150** (Lápiz digital sin goma)

**A DG:** a todo color (área para imágenes)  
**B DG:** a todo color (área para texto)

Cantidad mínima 500 unidades

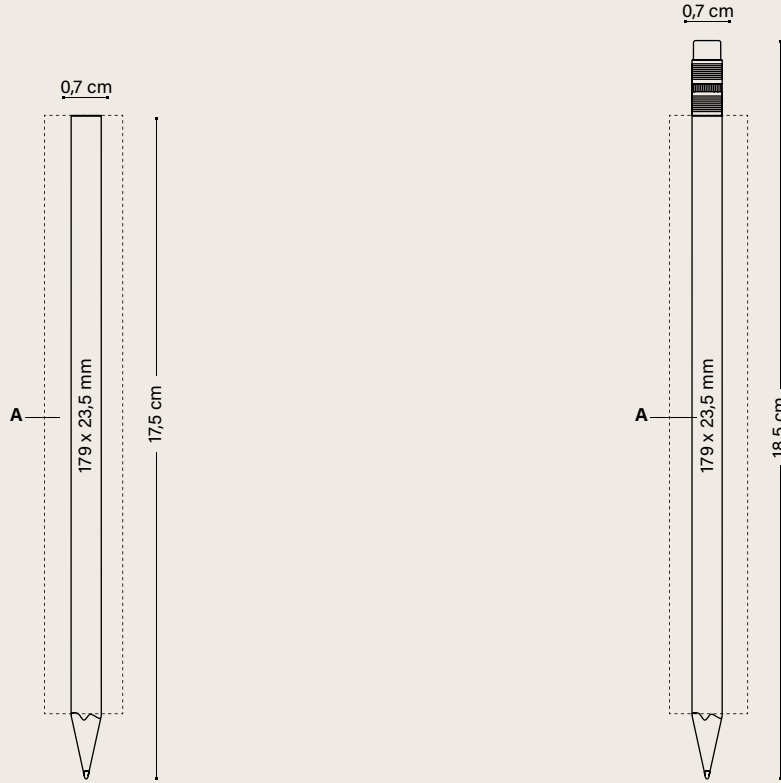

Personalización

**BIC® EVOLUTION® ECOLUTIONS®**  
**ECOLUTIONS® 1151** (Lápiz digital con goma)

ESPECIFICACIONES



FABRICADO E IMPRESO EN FABRICAS BIC



FABRICADO EN FRANCIA



CUMPLIMIENTO DE LA NORMATIVA



NEVERAS Y ENVASES DE YOGURT



RECICLABLE



BAJO IMPACTO AMBIENTAL



PUNTA RESISTENTE



NO SE ASTILLA



PROTECTOR DE MINA



FÁCIL DE USAR Y BORRAR

MODOS DE ESCRITURA



LÁPIZ PC HB Ø 2,3MM

TÉCNICAS DE IMPRESIÓN



SERIGRAFÍA



DIGITAL

ENVASE ESPECIAL OPCIONAL



PLASTIC POUCH (X 3 UNIDADES)

*¡Ahora puedes tenerlo en set!*

+ INFO PÁGS. 222 A 227

EMBALAJE EXTERIOR



500 ± 3,5 KG

Consulta la página 233 para una explicación detallada de los iconos

# SPROUT™ LÁPIZ DE GRAFITO



El único lápiz del mundo que puedes plantar al final de su uso para que crezcan hierbas, hortalizas y flores.

SPROUT™ LÁPIZ DE GRAFITO  
53062



Cuerpo estándar

Cuerpo personalizable

¡Cartón estándar!

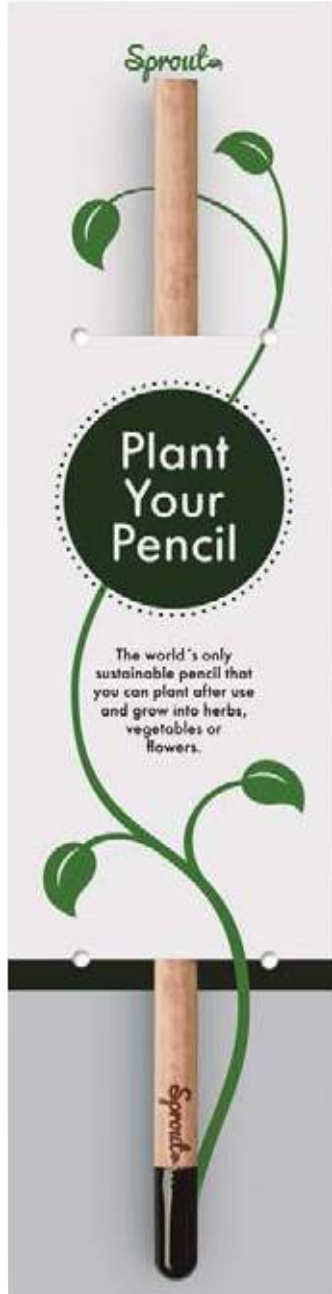

80%

Cartón no personalizable

¡Cartón personalizable!



80%

Cartón personalizable



Parte trasera



Mina de grafito

Una vez que el lápiz es demasiado corto para escribir, plántalo por la parte de arriba y mira como tu mensaje se convierte en una maceta de hermosas hierbas, flores o vegetales.

¡Escoge entre 11 semillas diferentes!

- |              |                |                   |
|--------------|----------------|-------------------|
| 1. Abeto     | 5. Noveobrides | 9. Cilantro       |
| 2. Girasol   | 6. Albahaca    | 10. Chia          |
| 3. Margarita | 7. Tomillo     | 11. Tomate cherry |
| 4. Clavel    | 8. Salvia      |                   |

Personalización

**SPROUT™ LÁPIZ DE GRAFITO**

53062

A LE  
B DG

Cantidad mínima 500 unidades  
Cantidad mínima 1000 unidades (lápiz + envase de cartón personalizable)

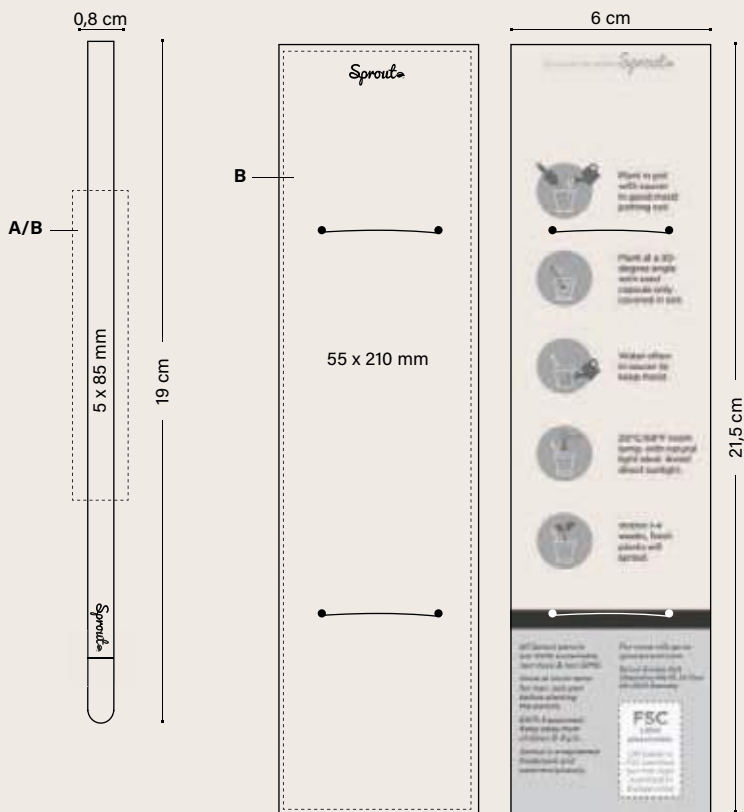

*Instrucciones para plantar incluidas en la parte de atrás. Para personalizar el cartón, se pueden cambiar la fuente y los colores!*

**EMBALAJE EXTERIOR**



500 ± 2,5 KG (SOLO LÁPIZ)  
± 5 KG (CON EMBALAJE DE CARTÓN)

**EMBALAJE**



**ESPECIFICACIONES**



Sprouta



FSC Y CARTÓN RECICLABLE



RECICLABLE

**MODOS DE ESCRITURA**



LÁPIZ PC HB Ø 2,3MM

**TÉCNICAS DE IMPRESIÓN**



LÁSER



DIGITAL



MIRA EL VÍDEO

Consulta la página 233 para una explicación detallada de los iconos

Índice

02

---



# OTROS INSTRUMENTOS DE ESCRITURA

---

## **BOLÍGRAFOS DE PLÁSTICO**

Basic Pen	172
Click Pen	174
Striped Grip Pen	176

## **BOLÍGRAFOS CON STYLUS**

Sleek Stylus Pen	178
------------------	-----

# BASIC PEN

---

## BASIC PEN

12010

Color de tinta



Personalización

## BASIC PEN 12010

A/B SP: máx. 1 col.

Cantidad mínima 500 unidades

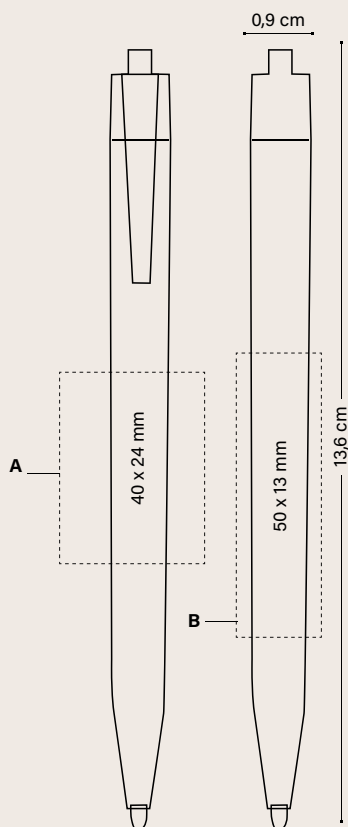

### EMBALAJE EXTERIOR



1000 ± 12,5 KG

#### ESPECIFICACIONES



IMPRESO EN  
FÁBRICAS BIC



CALIDAD Y  
SEGURIDAD APROBADA



CUMPLIMIENTO  
DE LA NORMATIVA



ISO  
certified  
IMPRIM'VERT®

#### MODOS DE ESCRITURA



BOLÍGRAFO M

#### TÉCNICAS DE IMPRESIÓN



SERIGRAFIA

# CLICK PEN

---

## CLICK PEN

11748

Color de tinta



01



03



24



04



05



02



10

100%

Personalización

**CLICK PEN**

11748

A/B SP: máx. 4 col.

C/D PD: máx. 4 col.

Cantidad mínima 500 unidades

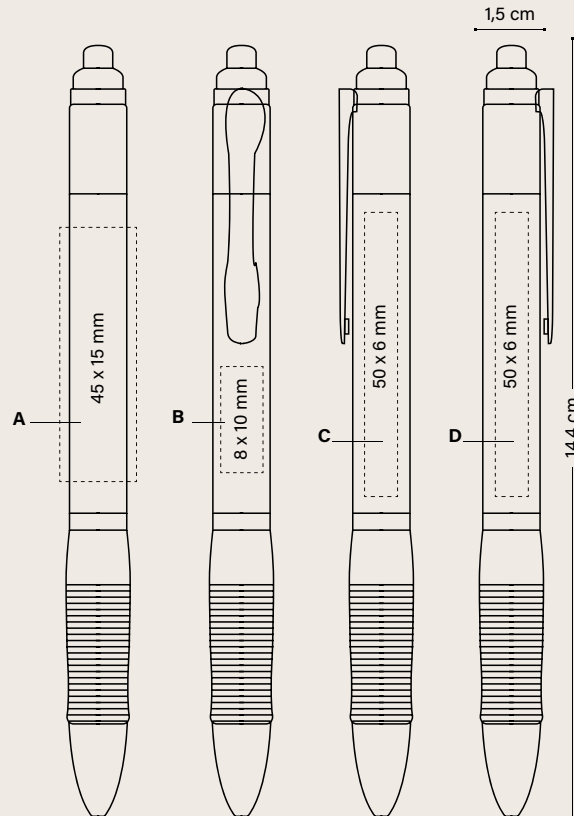

**EMBALAJE EXTERIOR**



1000 ± 9,5 KG

**ESPECIFICACIONES**



IMPRESO EN FÁBRICAS BIC



CALIDAD Y SEGURIDAD APROBADA



CUMPLIMIENTO DE LA NORMATIVA



ISO certified



IMPRIM'VERT®

**MODOS DE ESCRITURA**



BOLÍGRAFO M

**TÉCNICAS DE IMPRESIÓN**



SERIGRAFÍA



TAMPOGRAFÍA

# STRIPED GRIP PEN

---

---

## STRIPED GRIP PEN

11243

Color de tinta



10



03



24



8C



04

100%

Personalización

**STRIPED GRIP PEN**

11243

**A SP:** máx. 2 col.

**B PD:** máx. 1 col.

Cantidad mínima 500 unidades

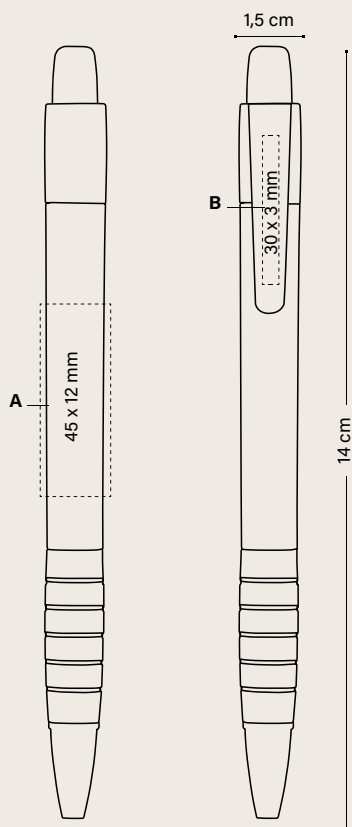

**EMBALAJE EXTERIOR**



1000 ± 9 KG

ESPECIFICACIONES



IMPRESO EN  
FÁBRICAS BIC



CALIDAD Y  
SEGURIDAD APROBADA



CUMPLIMIENTO  
DE LA NORMATIVA



IMPRIM'VERT®

MODOS DE  
ESCRITURA



BOLÍGRAFO M

TÉCNICAS DE  
IMPRESIÓN



SERIGRAFÍA



TAMPOGRAFÍA



# SLEEK STYLUS PEN

---

## SLEEK STYLUS PEN

11666

Color de tinta



01

## SLEEK STYLUS MATT PEN

11747

Color de tinta



47



04

## SLEEK STYLUS EXECUTIVE PEN

11976



26

● Disponible en tinta azul



2N

● Disponible en tinta negra

Personalización

**SLEEK STYLUS PEN**

11666

**SLEEK STYLUS MATT PEN**

11747

**SLEEK STYLUS EXECUTIVE PEN**

11976

**A SP:** máx. 1 col.

**B SP:** máx. 2 col.

**C LE**

Cantidad mínima 500 unidades (SP)

Cantidad mínima 100 unidades (LE)

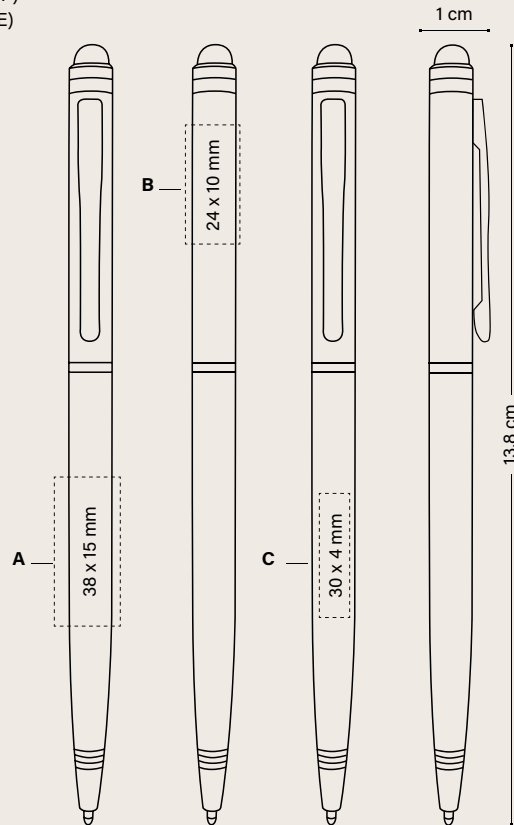

**EMBALAJE EXTERIOR**



(11666)  
900 ± 12,4 KG



(11747 / 11976)  
800 ± 13 KG

**ESPECIFICACIONES**



IMPRESO EN  
FÁBRICAS BIC



CALIDAD Y  
SEGURIDAD APROBADA



CUMPLIMIENTO  
DE LA NORMATIVA



ISO  
certified



IMPRIM'VERT®



BOLÍGRAFO M

**MODOS DE  
ESCRITURA**



STYLUS PEN

**TÉCNICAS DE  
IMPRESIÓN**



SP  
SERIGRAFÍA



LE  
LÁSER

Índice

03

---

# LIBRETAS

---

## **ROCKETBOOK®**

Rocketbook® Core Executive A5	184
Rocketbook® Fusion Executive A5	186
Rocketbook® Core Mini A6	188

# ROCKETBOOK®

---

Rocketbook® combina la libertad de un bolígrafo tradicional y un cuaderno de papel con su app para enviar notas escritas a mano de forma rápida y segura a tu carpeta en la nube. Está diseñado para ser la última libreta que necesitarás. Sigue las instrucciones incluidas para la página en blanco que se puede utilizar tantas veces como quieras. Puedes elegir entre el modelo Core para tomar notas, graficar o dibujar, o ve un paso más allá con el modelo Fusion para planificar, enumerar o establecer metas.

**Rocketbook® Core Executive A5**

**Rocketbook® Fusion Executive A5**

**Rocketbook® Core Mini A6**



# ROCKETBOOK® CORE EXECUTIVE A5



ROCKETBOOK® CORE EXECUTIVE A5  
3728

*Ganador del premio POP 2022 por el mejor marcaje.*



07  
●  
Color azul marino

01  
○  
Color blanco

02  
●  
Color negro

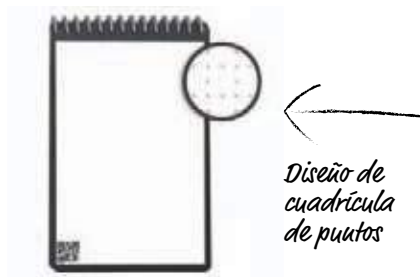

*La caja siempre incluye:*  
- Libreta  
- Bolígrafo  
- Paño  
- Instrucciones

Personalización

**ROCKETBOOK® CORE EXECUTIVE A5**

3728

**A SP:** máx. 1 col.

**B BP:** a todo color

**C HS:** máx. 1 col.

36 páginas

Cantidad mínima 50 unidades

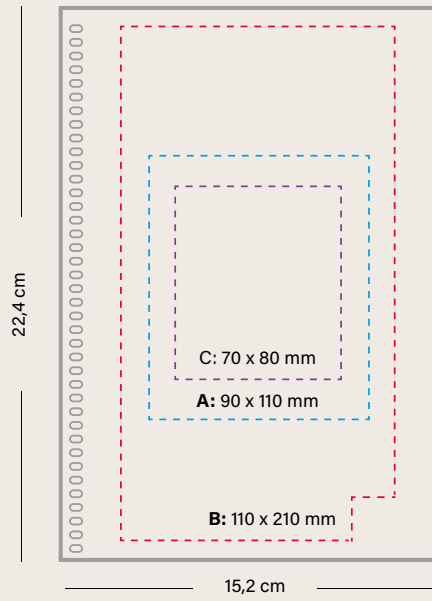

ESPECIFICACIONES



IMPRESO EN FABRICAS BIC



CUMPLIMIENTO DE LA NORMATIVA



IMPRIM'VERT®

APP DE ROCKETBOOK® DISPONIBLE EN



TÉCNICAS DE IMPRESIÓN



SERIGRAFÍA



BRITEPIX™



HOT STAMPING

ENVASE ESPECIAL SIEMPRE INCLUIDO



GIFT BOX CORE A5

EMBALAJE EXTERIOR



50 ± 5,8 KG



DESCARGA LA APP



COMO FUNCIONA

Consulta la página 233 para una explicación detallada de los iconos



# ROCKETBOOK® FUSION EXECUTIVE A5



ROCKETBOOK® FUSION EXECUTIVE A5  
372

Ganador del premio POP 2022 por el mejor marcaje.



01  
○  
Color blanco



02  
●  
Color negro



## 7 estilos de página

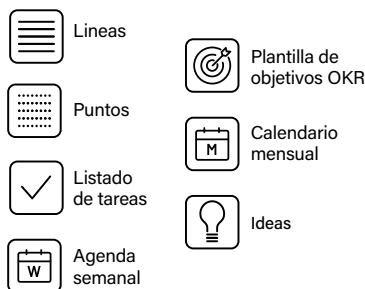

Personalización visible en el recorte de la ventana



La caja siempre incluye:

- Libreta
- Bolígrafo
- Paño
- Instrucciones

Personalización

**ROCKETBOOK® FUSION  
EXECUTIVE A5**

3726

**A SP:** máx. 1 col.

**B BP:** a todo color

**C HS:** máx. 1 col.

42 páginas

Cantidad mínima 50 unidades

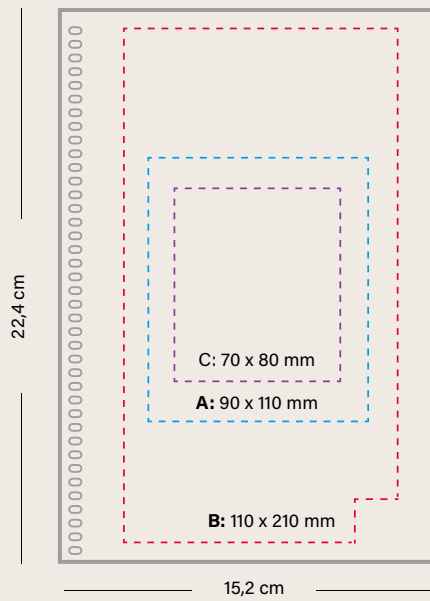

ESPECIFICACIONES



IMPRESO  
EN FABRICAS  
BIC



CUMPLIMIENTO  
DE LA NORMATIVA



IMPRIM'VERT®

APP DE  
ROCKETBOOK®  
DISPONIBLE EN



TÉCNICAS DE  
IMPRESIÓN



SERIGRAFÍA



BRITEPIX™



HOT STAMPING

ENVASE ESPECIAL SIEMPRE INCLUIDO



GIFT BOX  
FUSION A5

EMBALAJE EXTERIOR



50 ± 5,8 KG



DESCARGA LA APP



COMO FUNCIONA

Consulta la página 233 para una explicación detallada de los iconos

# ROCKETBOOK® CORE MINI A6



ROCKETBOOK® CORE MINI A6  
3727

*Ganador del premio POP 2022 por el mejor marcaje.*



01  
●  
Color blanco



02  
○  
Color negro



*Escribe*



*Escanea*



*Comparte*



*Reutiliza*

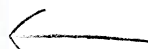

*Diseño de cuadrícula de puntos*

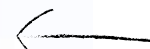

*Personalización visible en el recorte de la ventana*

*La caja siempre incluye:*

- Libreta
- Bolígrafo
- Paño
- Instrucciones

Personalización

**ROCKETBOOK® CORE  
MINI A6**

3727

**A SP:** máx. 1 col.

**B BP:** a todo color

**C HS:** máx. 1 col.

48 páginas

Cantidad mínima 50 unidades

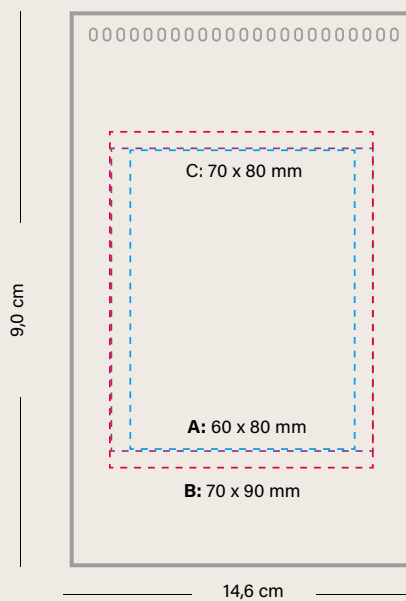

ESPECIFICACIONES



IMPRESO  
EN FABRICAS  
BIC



CUMPLIMIENTO  
DE LA NORMATIVA



IMPRIM'VERT®

APP DE  
ROCKETBOOK®  
DISPONIBLE EN



TÉCNICAS DE  
IMPRESIÓN



SERIGRAFÍA



BRITEPIX™



HOT STAMPING

ENVASE ESPECIAL SIEMPRE INCLUIDO



GIFT BOX  
CORE A6

EMBALAJE EXTERIOR



50 ± 2,6 KG



DESCARGA LA APP



COMO FUNCIONA

Consulta la página 233 para una explicación detallada de los iconos

# Índice

# 04

---

# ENCENDEDORES Y FUNDAS BIC®

---

## ENCENDEDORES

Encendedor BIC® J25	196
Encendedor BIC® J23	200
Encendedor BIC® J26	204
Encendedor BIC® J38	208

## FUNDAS

Funda BIC® Styl'it Luxury	212
Funda BIC® Aluminium Flat	214
Funda BIC® Clip	215
Funda BIC® 3D	216

## OTROS PRODUCTOS

Cenicero de bolsillo BIC®	218
---------------------------	-----



# Encendedores BIC®, Nuestra calidad, tu seguridad

Todos los encendedores de bolsillo BIC® cumplen o superan requisitos y normativas internacionales (ISO 9994, EN 13869, ASTM F400, US CPSC).

**1/3** Menos de 1/3 de los modelos de encendedor disponibles en el mercado europeo **CUMPLEN** con los estándares europeos de seguridad<sup>1</sup>.

**3%** Sólo el 3% de los encendedores electrónicos disponibles en Europa **CUMPLEN** con la normativa EN 13869 estándar<sup>2</sup>.

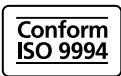

Altura de la llama, resistencia a las caídas, estabilidad de la llama y extinción de la llama son algunas de las características testadas por la norma ISO 9994.

<sup>1</sup>Fuente: pruebas realizadas de 2015 a 2018 por laboratorios independientes acreditados.



La norma EN 13869 requiere que todos los encendedores de bolsillo vendidos en la UE sean efectivamente a prueba de niños durante toda la vida útil del producto.

<sup>2</sup>Fuente: pruebas de SGS en 105 modelos de encendedor electrónico con desplazamiento vertical entre abril de 2017 y junio de 2018.

No es lo mismo un encendedor con seguridad para niños que un encendedor a prueba de niños.

Por “encendedor con seguridad para niños” se entiende un encendedor que para un mínimo del 85% de los niños de hasta 51 meses de edad resulta imposible de accionar. Esto significa que hasta un 15% de los niños sí podrán hacer funcionar el encendedor. De ahí que los adultos deban siempre impedir que los niños jueguen con encendedores, por seguros que éstos sean.

## ¡ELIGE BIEN! Encendedores de bolsillo BIC®







# ENCENDEDORES

## BIC®

---

El diseño icónico, querido y atemporal del encendedor BIC® ¡sigue siendo tendencia! 4 tamaños distintos y una amplia gama de combinaciones de colores.

**Encendedor BIC® J25**

**Encendedor BIC® J23**

**Encendedor BIC® J26**

**Encendedor BIC® J38**

**Funda BIC® Styl'it Luxury**

**Funda BIC® Aluminium Flat**

**Funda BIC® Clip**

**Funda BIC® 3D**

**Cenicero de bolsillo BIC®**



# ENCENDEDOR BIC® J25



*¡Icónico BIC® Boy  
y logo BIC®  
grabado!*

## ENCENDEDOR BIC® J25

2360

2364 All Black



01

57

57

8G

03

11



59

24

04

25

25

06



90

84\*

02

02

02

02

100%

Personalización

**ENCENDEDOR BIC® J25**

2360/2364

A/C SP: máx. 4 col.

Cantidad mínima 300 unidades

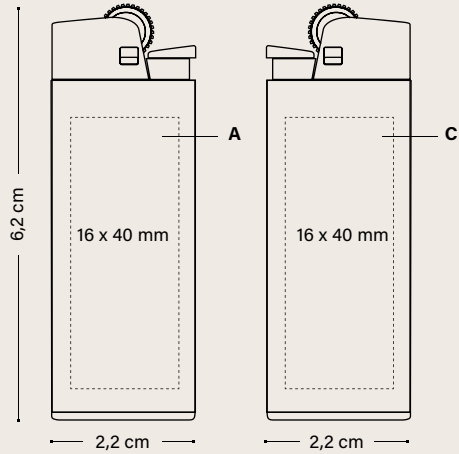

**ENCENDEDOR BIC® J25 BRITEPIX™**

2360 / 2364

A/C BP: a todo color

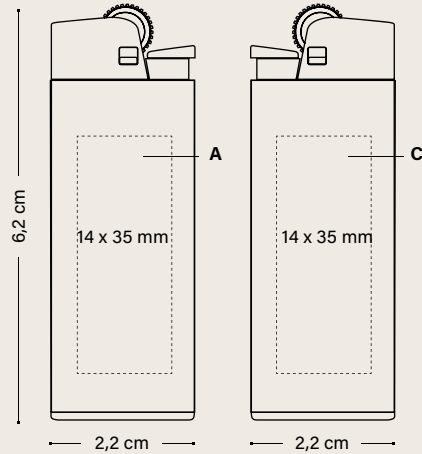

**EMBALAJE**



EMBALAJE ESTÁNDAR:  
EN BARQUETA DE 50 U.

¡100% reciclada!



**EMBALAJE EXTERIOR**



600 ± 7,6 KG



FSC Y CARTÓN  
RECICLABLE

**ESPECIFICACIONES**



FABRICADO E  
IMPRESO EN  
FÁBRICAS BIC



FABRICADO  
EN ESPAÑA



PASTEL  
HECHO EN FRANCIA



CUMPLIMIENTO  
DE LA NORMATIVA



HASTA 1.450

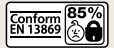

IMPRIM'VERT®



100% ELECTRICIDAD DE  
FUENTES RENOVABLES



BAJO IMPACTO  
AMBIENTAL

**TÉCNICAS DE  
IMPRESIÓN**



SERIGRAFÍA



BRITEPIX™

ACABADOS



**BR** BRILLIANT



**MT** MATT

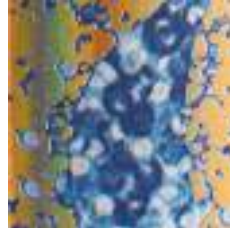

**H** HOLOGRAPHIC



**P** PUFFY



**M** METALLIC



**UV** UV



**SA** SANDY



**PG** PUFFY GLITTER

ENCENDEDOR BIC® J25 DIGITAL  
2360



**MT** MATT

**P** PUFFY



**BR** BRILLIANT

**P** PUFFY



**MT** MATT

**M** METALLIC

Personalización

## ENCENDEDOR BIC® J25 DIGITAL

2360

A DG: a todo color

Cantidad mínima 600 unidades

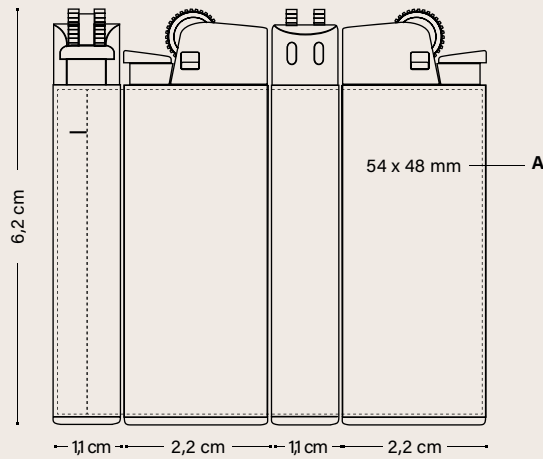

### ESPECIFICACIONES



### TÉCNICAS DE IMPRESIÓN



### EMBALAJE



EMBALAJE ESTÁNDAR:  
EN BARQUETA DE 50 U.

¡100% reciclada!

### EMBALAJE EXTERIOR



600 ± 7,6 KG



FSC Y CARTÓN  
RECICLABLE

Consulta la página 233 para una explicación detallada de los iconos

# ENCENDEDOR BIC® J23

*¡Icónico BIC® Boy  
y logo BIC®  
grabado!*

ENCENDEDOR BIC® J23  
2340



57



12



03



10

*¡Tan fino que encaja  
en cualquier sitio!*

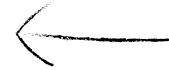

05



04



25



02



Personalización

**ENCENDEDOR BIC® J23**

2340

A/C SP: máx. 4 col.

Cantidad mínima 300 unidades

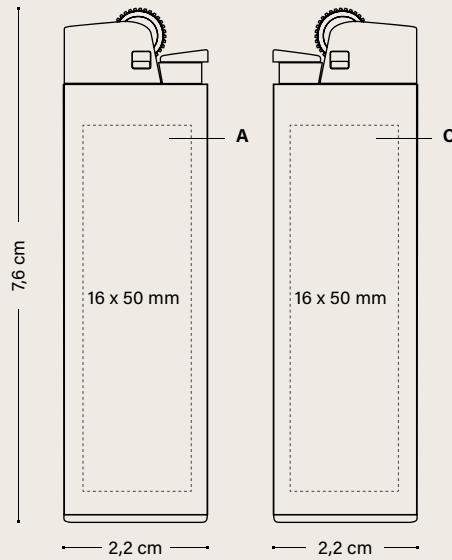

ESPECIFICACIONES



TÉCNICAS DE IMPRESIÓN



SERIGRAFÍA

EMBALAJE



¡100% reciclada!

EMBALAJE EXTERIOR



FSC Y CARTÓN RECICLABLE

ACABADOS



**BR** BRILLIANT



**MT** MATT

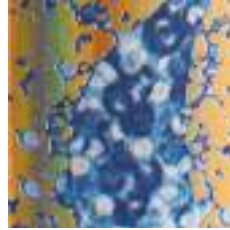

**H** HOLOGRAPHIC



**P** PUFFY



**M** METALLIC



**UV** UV



**SA** SANDY



**PG** PUFFY GLITTER

ENCENDEDOR BIC® J23 DIGITAL  
2340



**MT** MATT



**MT** MATT

**P** PUFFY

**M** METALLIC

**UV** UV



**BR** BRILLIANT

**P** PUFFY

Personalización

## ENCENDEDOR BIC® J23 DIGITAL

2340

A DG: a todo color

Cantidad mínima 600 unidades

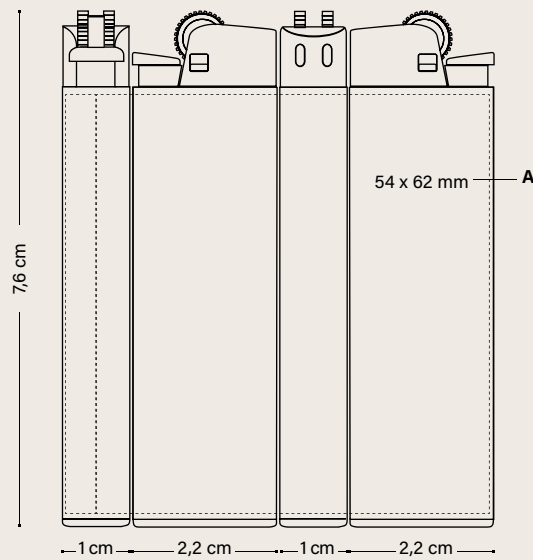

### ESPECIFICACIONES



FABRICADO EN FRANCIA



CUMPLIMIENTO DE LA NORMATIVA



HASTA 1.800



BAJO IMPACTO AMBIENTAL

### TÉCNICAS DE IMPRESIÓN



DIGITAL

### EMBALAJE



EMBALAJE ESTÁNDAR:  
EN BARQUETA DE 50 U.

¡100% reciclada!

### EMBALAJE EXTERIOR



600 ± 9,5 KG



FSC Y CARTÓN  
RECICLABLE

# ENCENDEDOR BIC® J26



*¡Icónico BIC® Boy  
y logo BIC®  
grabado!*

**ENCENDEDOR BIC® J26**  
2320



01



57



8G



10



06

100%

*Super duradero:  
¡hasta 3.000  
encendidos!*

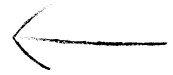

59



24



25



02



03

Personalización

**ENCENDEDOR BIC® J26**

2320

A/C SP: máx. 4 col.

Cantidad mínima 300 unidades

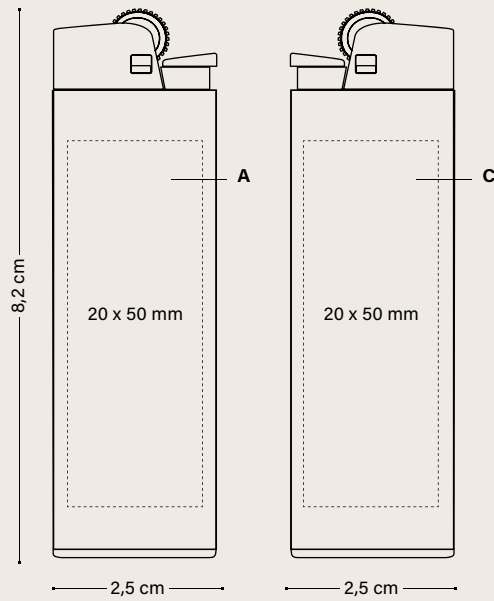

ESPECIFICACIONES



FABRICADO E IMPRESO EN FÁBRICAS BIC



FABRICADO EN ESPAÑA



CUMPLIMIENTO DE LA NORMATIVA



HASTA 3.000



100% ELECTRICIDAD DE FUENTES RENOVABLES



BAJO IMPACTO AMBIENTAL

TÉCNICAS DE IMPRESIÓN



SERIGRAFÍA

EMBALAJE



EMBALAJE ESTÁNDAR: EN BARQUETA DE 50 U.

¡100% reciclada!



EMBALAJE EXTERIOR



600 ± 15,1 KG



FSC Y CARTÓN RECICLABLE

Consulta la página 233 para una explicación detallada de los iconos

ACABADOS

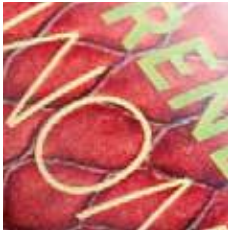

**BR** BRILLIANT



**MT** MATT

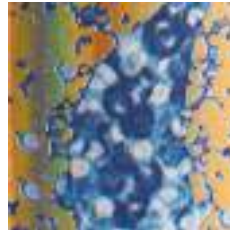

**H** HOLOGRAPHIC



**P** PUFFY



**M** METALLIC



**UV** UV



**SA** SANDY



**PG** PUFFY GLITTER

ENCENDEDOR BIC® J26 DIGITAL

2320



**BR** BRILLIANT

**M** METALLIC



**MT** MATT

**M** METALLIC

**P** PUFFY



**BR** BRILLIANT

**UV** UV

**H** HOLOGRAPHIC

Personalización

## ENCENDEDOR BIC® J26 DIGITAL

2320

A DG: a todo color

Cantidad mínima 600 unidades

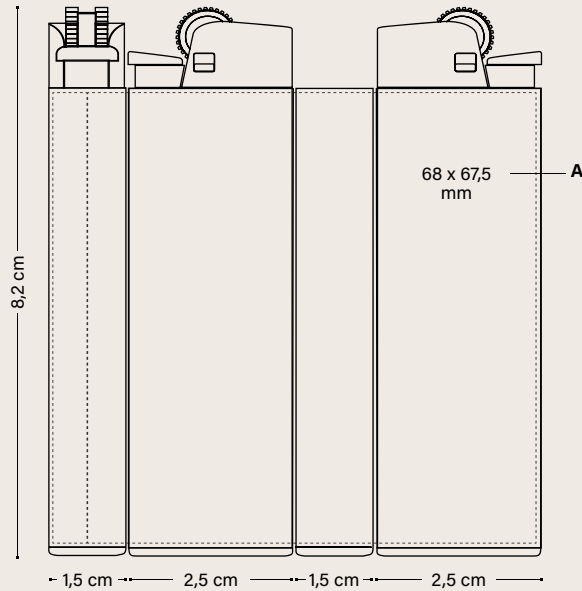

### ESPECIFICACIONES



### TÉCNICAS DE IMPRESIÓN



### EMBALAJE



EMBALAJE ESTÁNDAR:  
EN BARQUETA DE 50 U.

¡100% reciclada!

### EMBALAJE EXTERIOR



600 ± 15,1 KG



FSC Y CARTÓN  
RECICLABLE

Consulta la página 233 para una explicación detallada de los iconos



# ENCENDEDOR BIC® J38

---

*¡Icónico BIC® Boy  
y logo BIC®  
grabado!*

**ENCENDEDOR BIC® J38**  
2452



57



25



02



03

100%

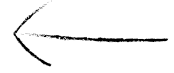

*¡Elegante y  
cómodo de  
encender!*

Personalización

**ENCENDEDOR BIC® J38**

2452

A/C SP: máx. 4 col.

Cantidad mínima 300 unidades

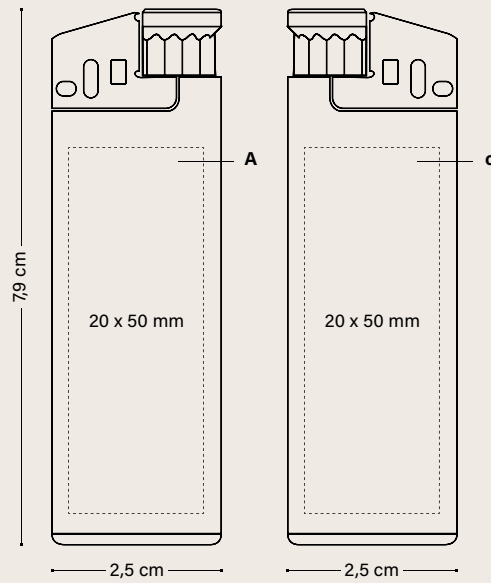

ESPECIFICACIONES



FABRICADO E IMPRESO EN FÁBRICAS BIC



FABRICADO EN ESPAÑA



CUMPLIMIENTO DE LA NORMATIVA



HASTA 1.800



IMPRIM'VERT®



100% ELECTRICIDAD DE FUENTES RENOVABLES



BAJO IMPACTO AMBIENTAL

TÉCNICAS DE IMPRESIÓN



SERIGRAFÍA

EMBALAJE



EMBALAJE ESTÁNDAR: EN BARQUETA DE 50 U.

¡100% reciclada!

EMBALAJE EXTERIOR



600 ± 13,2 KG



FSC Y CARTÓN RECICLABLE

Consulta la página 233 para una explicación detallada de los iconos

ACABADOS



**BR** BRILLIANT



**MT** MATT

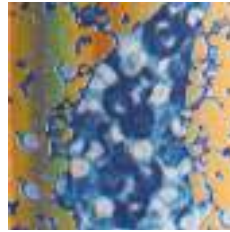

**H** HOLOGRAPHIC



**P** PUFFY



**M** METALLIC



**UV** UV



**SA** SANDY



**PG** PUFFY GLITTER

ENCENDEDOR BIC® J38 DIGITAL  
2452



57

**BR** BRILLIANT

**PG** PUFFY GLITTER



57

**BR** BRILLIANT

**SA** SANDY



100%

57

**BR** BRILLIANT

*impresión  
360°*

Personalización

## ENCENDEDOR BIC® J38 DIGITAL

2452

A DG: a todo color

Cantidad mínima 600 unidades

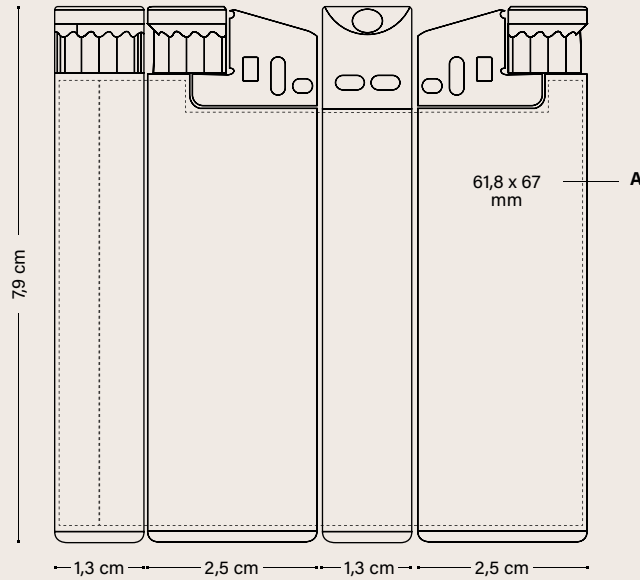

### ESPECIFICACIONES



FABRICADO E IMPRESO EN FABRICAS BIC



FABRICADO EN ESPAÑA



CUMPLIMIENTO DE LA NORMATIVA



HASTA 1800



100% ELECTRICIDAD DE FUENTES RENOVABLES



BAJO IMPACTO AMBIENTAL

### TÉCNICAS DE IMPRESIÓN



DIGITAL

### EMBALAJE



EMBALAJE ESTÁNDAR: EN BARQUETA DE 50 U.

¡100% reciclada!

### EMBALAJE EXTERIOR



600 ± 13,2 KG



FSC Y CARTÓN RECICLABLE

# FUNDA BIC® STYL'IT LUXURY

## FUNDA BIC® STYL'IT LUXURY 2386 Neon



*¡Todas las fundas se entregan con un encendedor BIC® J25 de color blanco!*



### Personalización

## FUNDA BIC® STYL'IT LUXURY 2386

Cantidad mínima 100 unidades  
**A/C LE**

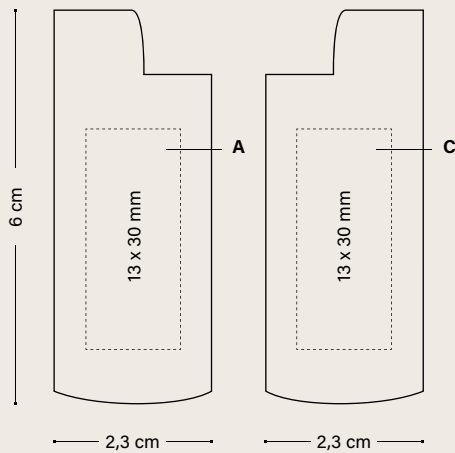

Cantidad mínima 100 unidades  
**A/C PD**

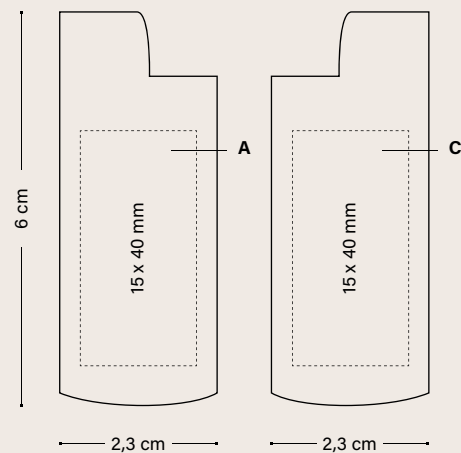

### ENVASE



ENVASE ESTÁNDAR:  
EN BARQUETA DE 10 U.

### EMBALAJE EXTERIOR



300 ± 6,1 KG



FSC Y CARTÓN  
RECICLABLE

### ESPECIFICACIONES



IMPRESO EN  
FÁBRICAS BIC



CUMPLIMIENTO  
DE LA  
NORMATIVA



IMPRIM'VERT®

### TÉCNICAS DE IMPRESIÓN



TAMPOGRAFÍA



LÁSER

**FUNDA BIC® STYL'IT LUXURY**  
2153 Soft



*¡Todas las fundas se entregan con un encendedor BIC® J25 de color blanco!*



47\*

**Personalización**

**FUNDA BIC® STYL'IT LUXURY**

2153

**A/C LE**

Cantidad mínima 100 unidades

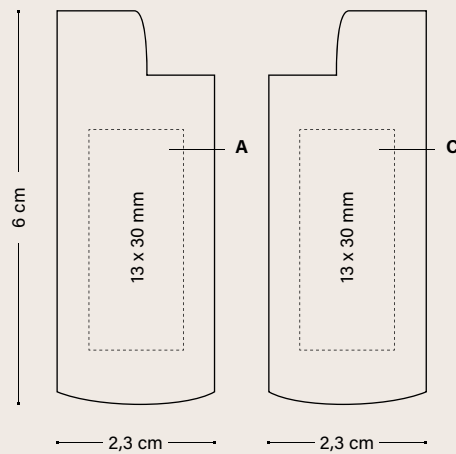

**ENVASE**



ENVASE ESTÁNDAR:  
EN BARQUETA DE 10 U.

**EMBALAJE EXTERIOR**



300 ± 6,1 KG



FSC Y CARTÓN  
RECICLABLE

**ESPECIFICACIONES**



IMPRESO EN  
FÁBRICAS BIC



CUMPLIMIENTO  
DE LA  
NORMATIVA



**TÉCNICAS DE IMPRESIÓN**



\*Hasta que se acabe el stock. Consulta la página 233 para una explicación detallada de los iconos

# FUNDA BIC® ALUMINIUM FLAT

## FUNDA BIC® ALUMINIUM FLAT 2156

*¡Con tres caras personalizables!*



*¡Todas las fundas se entregan con un encendedor BIC® J25 de color blanco!*



47\*



03\*

### Personalización

#### FUNDA BIC® ALUMINIUM FLAT 2156

Cantidad mínima 100 unidades  
A/C PD: máx. 1 col.

Cantidad mínima 100 unidades  
A/B/C BP: a todo color

Cantidad mínima 100 unidades  
A/B/C LE

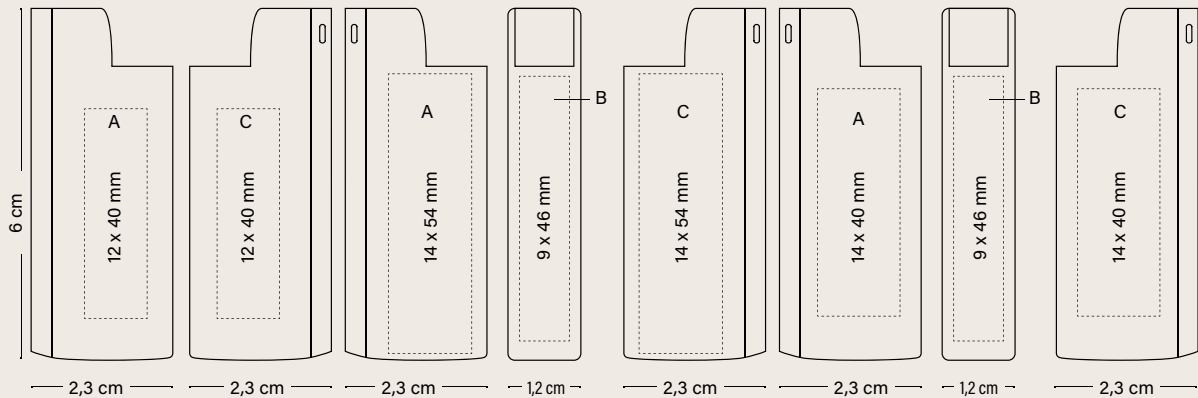

### ENVASE



ENVASE ESTÁNDAR:  
EN BARQUETA DE 50 U.

### EMBALAJE EXTERIOR



300 ± 6,9 KG



FSC Y CARTÓN  
RECICLABLE

### ESPECIFICACIONES



IMPRESO EN  
FÁBRICAS BIC



CUMPLIMIENTO  
DE LA  
NORMATIVA



### TÉCNICAS DE IMPRESIÓN



TAMPOGRAFÍA



LÁSER



BRITEPIX™  
BRITEPIX™ PERSONALISATION



## FUNDA BIC® CLIP 2398



*¡Todas las fundas se entregan con un encendedor BIC® 725 de color blanco!*



03\*



02\*



100%

### Personalización

## FUNDA BIC® CLIP 2398

Cantidad mínima 100 unidades  
A/C PD: máx. 1 col.

Cantidad mínima 100 unidades  
A/C BP: a todo color  
BP Texture: a todo color

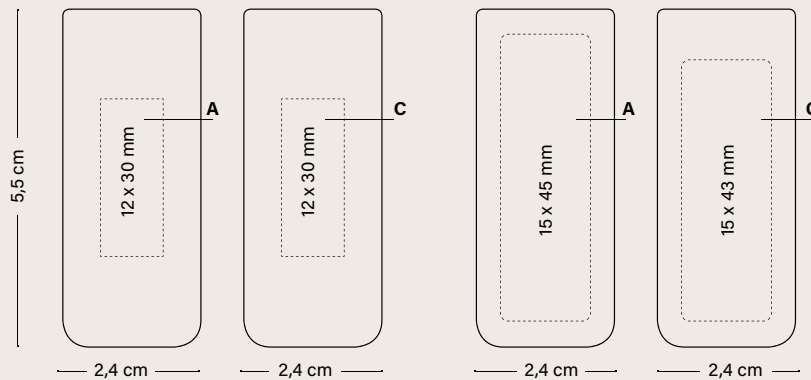

### ENVASE



ENVASE ESTÁNDAR:  
EN BARQUETA DE 50 U.

### EMBALAJE EXTERIOR



300 ± 7,5 KG



FSC Y CARTÓN  
RECICLABLE

### ESPECIFICACIONES



IMPRESO EN  
FÁBRICAS BIC



CUMPLIMIENTO  
DE LA  
NORMATIVA



### TÉCNICAS DE IMPRESIÓN



TAMPOGRAFÍA



BRITEPIX™  
BRITEPIX™ PERSONALISATION

## FUNDA BIC® 3D 2395



*¡Todas las fundas se entregan con un encendedor BIC® J25 de color blanco!*



*¡Convierte tu logo a una forma 3D!*

Personalización

**FUNDA BIC® 3D**

2395

A/C 3D: máx. 6 col.

Cantidad mínima 1.200 unidades

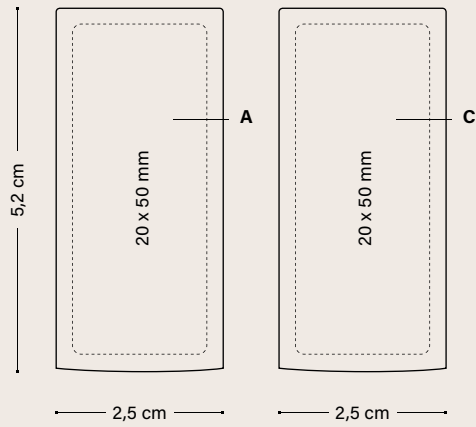

**ENVASE**



ENVASE ESTÁNDAR:  
EN BARQUETA DE 50 U.

**EMBALAJE EXTERIOR**



300 ± 7,5 KG



FSC Y CARTÓN  
RECICLABLE

**ESPECIFICACIONES**



CUMPLIMIENTO  
DE LA NORMATIVA



**TÉCNICAS DE  
IMPRESIÓN**



EMBOSSING

# CENICERO DE BOLSILLO BIC®

## CENICERO DE BOLSILLO BIC® 3850

*¡Disponibles 6  
formas de la  
solapa diferentes!*

*¡Reutilizable y  
hermético!*



### Personalización

## CENICERO DE BOLSILLO BIC® 3850

**A SP:** máx. 5 col. (máx. 2 col.  
para pedidos inferiores a 20.000 u.)

Cantidad mínima 5.000 unidades

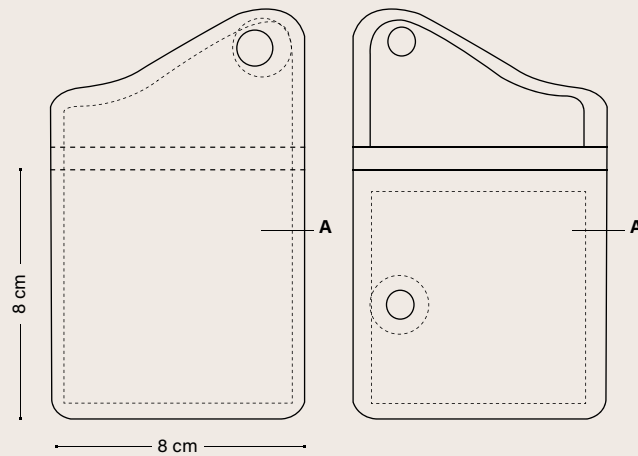

### ENVASE



CAJA DE 10 UNIDADES CADA  
CENICERO DE BOLSILLO BIC®  
VIENE CON UN EMBALAJE  
INDIVIDUAL DE CELOFÁN

### EMBALAJE EXTERIOR



500 ± 5,5 KG

### ESPECIFICACIONES



CUMPLIMIENTO  
DE LA  
NORMATIVA

### TÉCNICAS DE IMPRESIÓN



SERIGRAFÍA

**CENICERO DE BOLSILLO BIC®**  
3851 Kraft

*Imagen de respeto al medio ambiente*

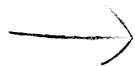

100%

**Personalización**

**CENICERO DE BOLSILLO BIC®**  
3851 Kraft

**A SP:** máx. 2 col.

Cantidad mínima 10.000 unidades

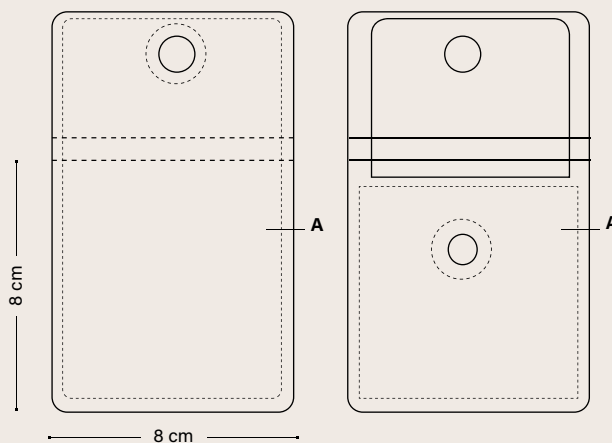

**ENVASE**



CAJA DE 10 UNIDADES CADA CENICERO DE BOLSILLO BIC® VIENE CON UN EMBALAJE INDIVIDUAL DE CELOFÁN

**EMBALAJE EXTERIOR**



500 ± 5,5 KG

**ESPECIFICACIONES**



CUMPLIMIENTO DE LA NORMATIVA

**TÉCNICAS DE IMPRESIÓN**



SERIGRAFÍA

Índice

05

---

# ENVASES BIC®

---

Envases BIC® Ecolutions®  
Envases BIC®

222  
224



¡NUEVO!

**BIC® COLLECTION BOX**

Caja de cartón FSC, personalizable en cada lado y que ofrece grandes superficies de comunicación. Ideal para ofrecer nuestros icónicos productos BIC® a través de una colección. Más que un bolígrafo, una gran manera de optimizar tus ventas.



*Envase especial para:*



- BIC® 4 COLOURS®
- BIC® WIDE BODY™
- BIC® SUPER CLIP
- BIC® BRITE LINER® GRIP
- BIC® GRIP ROLLER



**BIC® ECO SLEEVE**

985240

Funda especial reciclada para todos los instrumentos de escritura BIC® excepto los lápices de grafito.



*Envase especial para bolígrafos con el clip personalizado:*



- BIC® MEDIA CLIC
- BIC® CLIC STIC
- BIC® SUPER CLIP
- BIC® WIDE BODY™
- BIC® INTENSITY® GEL CLIC
- BIC® XS FINE STYLE

## BIC® WINDOW BOX

985241

Envase de diseño premium para todos los instrumentos de escritura BIC® excepto los lápices de grafito.



FSC Y CARTÓN  
RECICLABLE



Envase especial:



BIC® METAL PENS

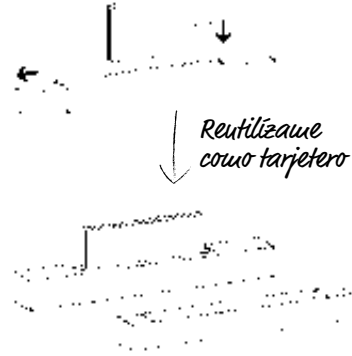

## BIC® PLASTIC POUCH

985242

Diseño especial para este envase que encaja con todos los instrumentos de escritura BIC y los 3 lápices de grafito.



FSC Y CARTÓN  
RECICLABLE



PLÁSTICO  
RECICLABLE



Úsase como  
punto de libro



## BIC® MARKING SET

985243

Envasado diseñado para todo tipo de marcadores.



FSC Y CARTÓN  
RECICLABLE



PLÁSTICO  
RECICLABLE



Envase especial para:



3 BIC® BRITE LINER® GRIP  
3 BIC® MARK-IT



3 BIC® VELLEDA® GRIP  
3 BIC® VELLEDA® FINE

Úsase como  
punto de libro



### ESPECIFICACIONES



FABRICADO  
EN ESPAÑA



CUMPLIMIENTO  
DE LA NORMATIVA



eColutions®



ECHA UN VISTAZO  
A LA INICIATIVA  
TREETDOM®

## BIC® CELLO WRAP

971634 / 971635 / 971636 / 971637

Envase de plástico transparente.



Cello wrap 1 unidad



Cello wrap 2 unidades

---

## BIC® BLACK VELVET POUCH 1 UNIDAD

974216

Envasado exclusivo de terciopelo para 1 instrumento de escritura para 1 o 2 productos.

Especialmente indicado para bolígrafos metálicos.

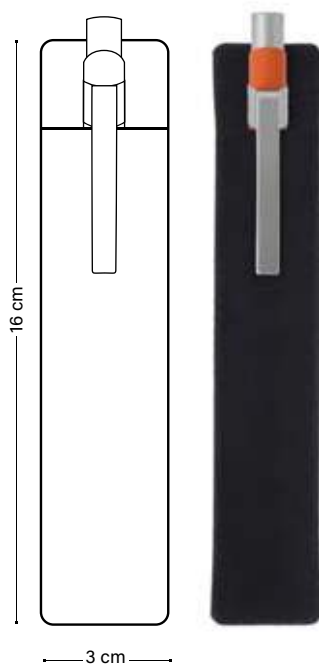

**BIC® CARTON BLACK&SILVER  
COLOUR GIFT BOX**

974218\*

Caja para todos los instrumentos de escritura, excepto los lápices de grafito.



60%

**BIC® FROSTED POUCH (PARA 1 Ó 2 UNIDADES)**

971640\*

Envase transparente para dos instrumentos de escritura

A SP: máx. 1 col.

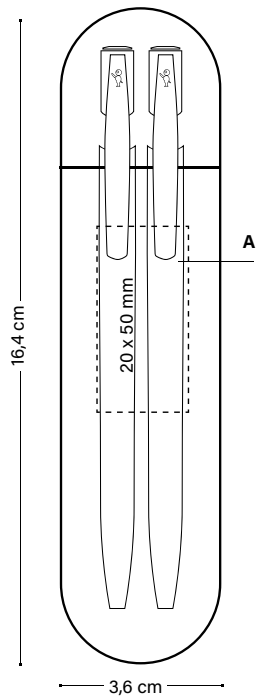

50%

**TÉCNICAS DE IMPRESIÓN**

SP SERIGRAFÍA

**BIC® SEE-THROUGH GIFT BOX  
(PARA 1 Ó 2 UNIDADES)**

974599\*

Caja, con ventana especial, para todos los instrumentos de escritura, excepto los lápices de grafito.



30%

\*Hasta que se acabe el stock

## COUNT BOX

**Pequeña** (para 25 BIC® Clic Stic)

**Mediana** (para 50 BIC® Media Clic o bolígrafo BIC® de las mismas dimensiones)

**Grande** (sólo para 100 BIC® Evolution® Ecolutions®)



## PLASTIC BAG

**Pequeña** (para 25 BIC® Media Clic o bolígrafo BIC® de las mismas dimensiones)

**Mediana** (para 50 BIC® Media Clic o bolígrafo BIC® de las mismas dimensiones)

**Grande** (para 100 BIC® Media Clic o bolígrafo BIC® de las mismas dimensiones)



## TRAY OF 10 WRITING INSTRUMENTS





**COUNT BOX 10U. CASES**  
976382



**COUNT BOX 10U. CASES CHILD RESISTANT**  
976403



**COUNT BOX 10U. J25 CHILD RESISTANT**  
974635



**BOX OF 50U. METAL STYL'IT CASE**  
977852



**BIC® OUTER BOXES**

Diseño especial para todas las cajas exteriores de todos los instrumentos de escritura.



FSC Y CARTÓN RECICLABLE



FABRICADO EN ESPAÑA

**BIC® OUTER BOXES**

Diseño especial para las cajas de encendedores.



FSC Y CARTÓN RECICLABLE



FABRICADO EN ESPAÑA

**TRAY OF 50 BIC® LIGHTERS**



BANDEJA 100% RECICLADA



# Índice



# SÍMBOLOS Y ABREVIATURAS

## SÍMBOLOS DE TÉCNICAS DE IMPRESIÓN

- PG** **Puffy glitter**  
Textura de color brillante.
- P** **Puffy**  
Resalta tu personalización dándole efecto relieve a tu logo.
- BR** **Brilliant**  
Acabado brillante.
- M** **Metallic**  
Crea efectos metálicos en imágenes o fondos.
- H** **Holographic**  
Convierte tu logo en una imagen tridimensional usando hologramas.
- MT** **Matt**  
Acabado mate.
- UV** **UV**  
Acabado super brillante.
- SA** **Sandy**  
Textura granulada con efecto arena.
- HS** **Hot Stamping**  
Grabado en relieve sensible al tacto.
-  **Print 360° bolígrafo**
-  **Print 360° encendedor**
-  **Digital**  
Cuatricromía de alta definición. 360° en el cuerpo entero.
-  **britePix™**  
Impresión a todo color con resultados fotográficos de alta calidad que asegura una impresión duradera de su logo.
-  **britePix™ Texture**  
britePix™ Texture es un añadido premium al concepto britePix™ - ahora no sólo puedes verlo sino que ¡también puedes sentirlo!
-  **britePix™ Digital**  
La solución para una impresión a todo color. Ahora en cuerpos de colores.
-  **britePix™ personalisation**  
Personalización britePix™. Personaliza cada unidad en el mismo pedido britePix™.

- SP** **Serigrafía**
- LE** **Láser**
- PD** **Tampografía**
- DG** **Digital**
- BP** **britePix™**
- 3D** **Relieve 3D**

## COLORES DE LA TINTA

- Negro
- Azul pastel
- Azul claro
- Azul oscuro
- Rojo
- Naranja
- Amarillo
- Amarillo Pastel
- Verde claro
- Verde Pastel
- Verde Manzana
- Verde oscuro
- Fluo
- Rosa coral
- Rosa
- Morado Pastel
- Morado

## MODOS DE ESCRITURA

-  **Bolígrafo** | M Medium  
F Fine
-  **Portaminas MP**
-  **Lápiz PC**
-  **Roller R**
-  **Resaltador HL**
-  **Stylus Pen SP**
-  **Escritura Finestyle FS**  
Ø 0,7mm
-  **Gel G**
-  **Marcador MK**
-  **Punta resistente**
-  **No se astilla**
-  **Fácil de usar y borrar**
-  **Escritura más suave y oscura**
-  **Escritura más suave y fluida**
-  **Resistente a los golpes**
-  **No se seca**
-  **Protector de mina**
-  **2 minas**

## OTROS SÍMBOLOS

	<b>Nuevo</b>	<b>ecolutions®</b>		<b>Reducción viral 93% en 24h</b>
	<b>48 Horas</b> Servicio de impresión en 48h			<b>Protección de la superficie del bolígrafo</b>
	<b>Mix&amp;Match</b> Cientos de componentes de instrumentos de escritura para una completa personalización			<b>Protección permanente</b>
	<b>Colores personalizados</b> Elija el color exacto PMS que mejor se adapte a su logo.			<b>Protección contra las bacterias</b>
	<b>Fabricado e impreso en fábricas BIC</b>			<b>Inhibición de hongos 24h</b>
	<b>Fabricado en fábricas BIC</b>			<b>Cumplimiento de la normativa</b>
	<b>Impreso en fábricas BIC</b>			<b>EN 13869</b> Regulaciones Europeas para encendedores con seguridad para niños.
	<b>Montaje e impresión en fábricas BIC</b>			<b>Certificado ISO</b>
	<b>Calidad y seguridad aprobada</b>			<b>ISO</b> Normas internacionales de seguridad
	<b>País de origen</b>			<b>Número de encendidos</b>
	<b>Fabricado en Francia</b>			<b>QR code</b> Escanea el código QR y mira el video
				<b>Información de envasado</b>
			250 ± 3,5 KG	<b>DIMENSIONES:</b> Las dimensiones publicadas en cada producto corresponden a su tamaño máximo, independientemente de la posición que muestre el dibujo.
		<b>Imprim'vert</b>		
		<b>Möbius Loop</b> El producto contiene material reciclado. Para más información sobre nuestros productos BIC Ecolutions® y cómo están hechos visita: <a href="https://www.bicworld.com/fr/nos-engagements/en-bref">https://www.bicworld.com/fr/nos-engagements/en-bref</a>		

# INFORMACIÓN GENERAL

## INFORMACIÓN SOBRE ARCHIVOS

En cualquier caso, los archivos deben ser dos:

- Un archivo electrónico con el diseño gráfico (creatividad) y otro archivo distinto para el texto.
- Para un grabado en láser, facilite los textos únicamente en formato Excel®. (.xls).

## PROPIEDADES DEL MATERIAL GRÁFICO

Envíenos su material gráfico en alguno de los siguientes tipos de archivo:

- JPG/ 350 dpi sin comprimir al tamaño real de impresión (sólo imágenes, sin texto)
- PDF / vectorizado
- Illustrator® CC / vectorizado
- Photoshop® CC / con capas
- Archivos ZIP

Es importante que nos proporcione la información en uno de estos formatos para agilizar su pedido y para obtener un resultado final adecuado. Si el diseño del cliente no encajase correctamente en el área de impresión, lo modificaremos consecuentemente.

## FUENTES:

Todos los tipos de letra se deben convertir en un arte final. Verifique los tamaños de los tipos mínimos y grosores de línea. Por favor, contacte con Atención al Cliente para más información.

## ESPECIAL PARA INSTRUMENTOS DE ESCRITURA

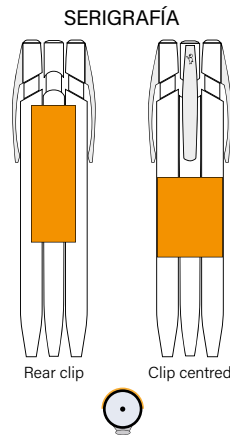

Área de impresión disponible según la técnica de impresión.

## ESPECIAL PARA ENCENDEDORES EN DIGITAL (J25, J23, J26 Y J38)



En el caso de querer un color directo, podemos ofrecer la impresión con un 5º color de dicha Guía. Para una mejor coincidencia de colores entre los diferentes productos de nuestro catálogo, póngase en contacto con nuestro departamento de Atención al Cliente.

## PARÁMETROS TÉCNICOS PARA CADA TIPO DE IMPRESIÓN

	DIGITAL / TRANSFERENCIA DIGITAL	
<b>Texto mínimo positivo</b>	4 pt (1.4 mm)	4 Point text
<b>Texto mínimo negativo</b>	7 pt (2.4 mm)	7 Point text
<b>Grosor mínimo de marca de agua</b>	1.5 pt (0.5 mm)	7 Point text
<b>Grosor mínimo para líneas positivas</b>	0.25 pt (0.08 mm)	_____
<b>Grosor mínimo para líneas negativas</b>	0.5 pt (0.17 mm)	██████████
<b>Grosor mínimo de marca de agua</b>	0.5 pt (0.17 mm)	_____
<b>Valores mínimos de marca de agua</b>	C: 8% / M: 8% / Y: 12% / K: 8%	

	britePix™	
<b>Texto mínimo positivo</b>	6 pt (2.1 mm)	6 Point text
<b>Texto mínimo negativo</b>	7 pt (2.4 mm)	7 Point text
<b>Grosor mínimo para líneas positivas</b>	0.4 pt (0.14 mm)	_____
<b>Grosor mínimo para líneas negativas</b>	0.5 pt (0.17 mm)	██████████
<b>Grosor mínimo de marca de agua</b>	1 pt (0.35 mm)	_____
<b>Porcentajes de marca de agua</b>		

	SERIGRAFÍA	HOT STAMPING / GRABADO EN RELIEVE	LÁSER
<b>Texto mínimo positivo</b>	6 pt (2.1 mm) 6 Point text	10 pt (3.5 mm) 10 Point text	6 pt (2.1 mm) 6 Point text
<b>Texto mínimo negativo</b>	9 pt (3.1 mm) 9 Point text	15 pt (5.25 mm) 15 Point	NO RECOMENDADO
<b>Grosor mínimo para líneas positivas</b>	0.4 pt (0.14 mm) _____	1.5 pt (0.5 mm) _____	0.3 pt (0.1 mm) _____
<b>Grosor mínimo para líneas negativas</b>	0.5 pt (0.176 mm) ██████████	2 pt (0.706 mm) ██████████	0.5 pt (0.17 mm) ██████████
<b>Grosor mínimo de marca de agua</b>	1.5 pt (0.5 mm) _____	NO POSIBLE	NO POSIBLE
<b>Porcentajes de marca de agua</b>	50% ██████████		

## INSTRUMENTOS DE ESCRITURA BIC®

BIC® Style _____	<b>38</b>
BIC® Round Stic® _____	<b>42</b>
BIC® Round Stic® BGuard™ antibacterial _____	<b>48</b>
BIC® M10® Clic _____	<b>50</b>
BIC® Media Clic _____	<b>52</b>
BIC® Media Clic Grip _____	<b>58</b>
BIC® Media Clic BGuard™ antibacterial _____	<b>63</b>
BIC® Media Clic BGuard™ antimicrobial Ecolutions® _____	<b>66</b>
BIC® Media Clic Bio-Based Ecolutions® _____	<b>68</b>
BIC® Media Clic Bio-Based BGuard™ antibacterial _____	<b>71</b>
BIC® Media Clic Shine _____	<b>73</b>
BIC® Media Clic Glacé _____	<b>74</b>
BIC® Clic Stic _____	<b>76</b>
BIC® Clic Stic BGuard™ antibacterial _____	<b>84</b>
BIC® Clic Stic Stylus BGuard™ antibacterial _____	<b>86</b>
BIC® Super Clip _____	<b>88</b>
BIC® Super Clip BGuard™ antibacterial _____	<b>94</b>
BIC® Super Clip Advance _____	<b>96</b>
BIC® Super Clip Glacé _____	<b>100</b>
BIC® Super Clip Glacé Advance _____	<b>100</b>
BIC® Super Clip Soft _____	<b>102</b>
BIC® Super Clip Soft Advance _____	<b>102</b>
BIC® Super Clip Origin _____	<b>104</b>
BIC® Wide Body™ _____	<b>106</b>
BIC® Wide Body™ BGuard™ antibacterial _____	<b>112</b>
BIC® 4 Colours® _____	<b>114</b>
BIC® 4 Colours® Soft _____	<b>118</b>
BIC® 4 Colours® Wood Style _____	<b>120</b>
BIC® 4 Colours® Sun _____	<b>122</b>
BIC® 4 Colours® Fashion _____	<b>124</b>
BIC® 4 Colours® Shine _____	<b>126</b>
BIC® 4 Colours® Glacé _____	<b>128</b>
BIC® 4 Colours® Fine _____	<b>130</b>
BIC® 4 Colours® Fluo _____	<b>131</b>
BIC® 4 Colours® 3+1 <sup>HB</sup> _____	<b>132</b>
BIC® Metal Pro _____	<b>134</b>
BIC® Cristal® Re'New™ _____	<b>138</b>
BIC® Grip Roller _____	<b>142</b>
BIC® XS Finestyle _____	<b>146</b>
BIC® Intensity® Gel Clic _____	<b>148</b>
BIC® Brite Liner® Grip _____	<b>152</b>
BIC® Velleda® White Board Marker Fine _____	<b>154</b>
BIC® Velleda® White Board Marker Grip _____	<b>155</b>
BIC® Mark-It Permanent Marker _____	<b>156</b>
BIC® Permanent Marker Ecolutions® _____	<b>157</b>
BIC® Matic® _____	<b>160</b>
BIC® Evolution® Ecolutions® _____	<b>164</b>
Sprout™ Lápiz de grafito _____	<b>168</b>

## OTROS INSTRUMENTOS DE ESCRITURA

Basic Pen _____	
Click Pen _____	
Striped Grip Pen _____	
Sleek Stylus Pen _____	

## LIBRETAS

Rocketbook® Core Executive A5 _____	
Rocketbook® Fusion Executive A5 _____	
Rocketbook® Core Mini A6 _____	

## ENCENDEDORES Y FUNDAS BIC®

Encendedor BIC® J25 _____	
Encendedor BIC® J23 _____	
Encendedor BIC® J26 _____	
Encendedor BIC® J38 _____	
Funda BIC® Styl'it Luxury _____	
Funda BIC® Aluminium Flat _____	
Funda BIC® Clip _____	
Funda BIC® 3D _____	
Cenicero de bolsillo BIC® _____	

## ENVASES BIC®

Envases BIC® Ecolutions® _____	
Envases BIC® _____	

# GAMA DE COLORES

<b>01</b> Blanco	<b>1E</b> Blanco reciclado	<b>57</b> Blanco Opaco	<b>3C</b> Blanco perlado	<b>01BIO</b> Blanco Bio	<b>1T</b> Blanco polished	<b>51</b> Transparente	<b>69</b> Blanco frosted	<b>2E</b> Blanco frosted reciclado	<b>1R</b> Blanco transparente	
<b>8D</b> Amarillo pastel	<b>8G</b> Amarillo claro	<b>12</b> Amarillo	<b>12W</b> Amarillo madera	<b>8T</b> Amarillo polished	<b>63</b> Amarillo frosted	<b>6AW</b> Madera natural	<b>012BIO</b> Amarillo Bio	<b>4D</b> Amarillo transparente	<b>6F</b> Marrón claro	<b>07</b> Natural
<b>26</b> Dorado	<b>76</b> Dorado glacé	<b>1G</b> Naranja ácido	<b>10</b> Naranja	<b>6P</b> Naranja polished	<b>90</b> Naranja pastel	<b>71</b> Naranja frosted	<b>92</b> Naranja transparente			
<b>03</b> Rojo	<b>03G</b> Rojo glacé	<b>03F</b> Rojo soft	<b>3T</b> Rojo polished	<b>8E</b> Rojo reciclado	<b>87</b> Rojo transparente	<b>03BIO</b> Rojo Bio	<b>66</b> Rojo frosted	<b>08</b> Burdeos		
<b>14</b> Rosa	<b>5C</b> Rosa fúcsia	<b>6T</b> Rosa polished	<b>1P</b> Rosa ácido	<b>014G</b> Rosa glacé	<b>07</b> Rosa dorado	<b>11</b> Rosa				
<b>84</b> Violeta pastel	<b>13</b> Violeta	<b>39</b> Violeta frosted	<b>7G</b> Violeta metálico	<b>2D</b> Violeta	<b>93</b> Violeta oscuro transparente	<b>9T</b> Violeta polished				
<b>8C</b> Lima	<b>68</b> Verde frosted	<b>6C</b> Verde hierba	<b>88</b> Verde claro transparente	<b>59</b> Verde Manzana	<b>5P</b> Verde polished	<b>82</b> Verde oscuro frosted	<b>72</b> Verde transparente	<b>5G</b> Verde claro	<b>05G</b> Verde glacé	
<b>5T</b> Verde polished	<b>05</b> Verde	<b>05W</b> Verde madera	<b>20</b> Verde oscuro	<b>7E</b> Verde oscuro reciclado	<b>88</b> Verde oscuro transparente	<b>05BIO</b> Verde Bio	<b>3B</b> Jungla frosted			
<b>83</b> Azul pastel	<b>3D</b> Azul caribeño	<b>4T</b> Azul caribeño polished	<b>86</b> Azul transparente	<b>67</b> Azul frosted	<b>24</b> Azul claro	<b>04BIO</b> Azul Bio	<b>04</b> Azul	<b>04G</b> Azul glacé	<b>40</b> Azul oscuro frosted	
<b>34</b> Azul claro metálico	<b>89</b> Azul oscuro transparente	<b>25</b> Azul oscuro	<b>07</b> Azul marino	<b>07F</b> Azul marino soft	<b>10E</b> Azul marino reciclado	<b>7T</b> Azul marino polished				
<b>35</b> Cromado	<b>47</b> Plata	<b>47G</b> Plateado glacé	<b>75</b> Metálico silver	<b>18</b> Metal	<b>06</b> Gris	<b>27</b> Gris oscuro	<b>8L</b> Gris polished	<b>8H</b> Gris oscuro transparente	<b>7A</b> Gris sombra	
<b>02BIO</b> Negro Bio	<b>02W</b> Negro madera	<b>02F</b> Negro soft	<b>2T</b> Negro polished	<b>02</b> Negro	<b>3E</b> Negro reciclado	<b>2N</b> Negro mate				

*365 días a  
tu lado!®*

